

Wireless Data Logging System

RTR-500 Series



Remote Unit (Data Logger)

Measure / Record

- Temperature • Pt100 / Pt1000 • Thermocouple
- Humidity • Voltage • 4-20mA • Pulse
- Illuminance • UV • CO2



Wireless Communication

Base Unit

Data Collection

- Recorded Data Collection via Wireless Communication
- Warning Monitoring Function
- Monitoring Function

RTR-500DC

Portable Data Collector



RTR-500

Wireless Base Station



Viewing Graph on Site

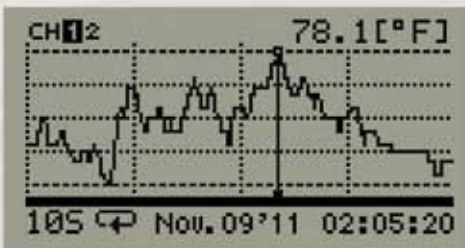

Reading Data from a Graph and Spreadsheet

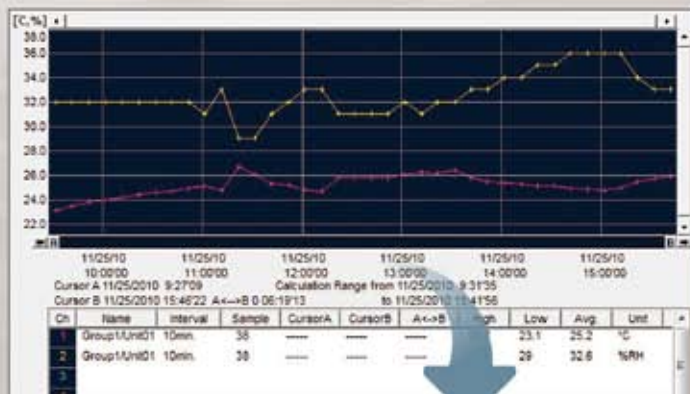

Export



Monitoring for Warning and Current Readings on PC

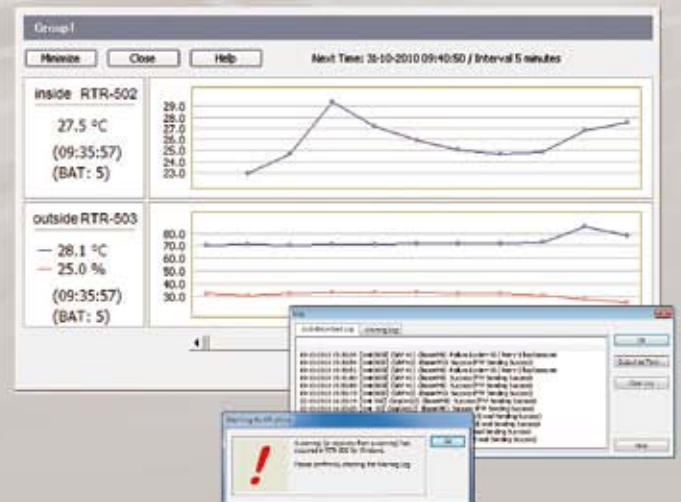

Versatile Next Generation Design for Today

The RTR-500 Series includes data loggers designed to measure and record a wide variety of items as well as a range of base stations to enable wireless collection of recorded data.

The collected data can be easily accessed via PC, Cloud, and/or E-mail.

Moreover, various functions, such as the monitoring of current readings and warning notification, make it a powerful data management system.



Variety of Wireless Data Logger Selections to

Temperature



RTR-501 / RTR-501L

Measurement Range: -40 to 80°C
Water Resistance: IP67 (Immersion Proof)
Temperature Sensor: Thermistor



RTR-502 / RTR-502L

Measurement Range: -60 to 155°C
Water Resistance: IP64 (splash proof / rated for use in daily life)
Attached Sensor: Temperature Sensor (TR-5106)

Temperature / Humidity



RTR-503 / RTR-503L

Measurement Range:
Temperature: 0 to 55°C
Humidity: 10 to 95 %RH
Attached Sensor: Temperature / Humidity Sensor (TR-3310)

Voltage



RTR-505-V / RTR-505-VL

Measurement Range: 0 to 22 V
Attached Module: Input Module (VIM-3010)
Measurement Resolution: Minimum of 0.1 mV
Preheat Function

4-20mA



RTR-505-mA / RTR-505-mAL

Measurement Range: 0 to 20 mA (Operational up to 40 mA)
Attached Module: Input Module (AIM-3010)

Pulse Count



RTR-505-P / RTR-505-PL

Measurement Range: Pulse count 0 to 61,439
Signal Input: Contact Input / Voltage Input
Input Frequency: 0 to 3.5 kHz
Attached Cable: Input Cable (PIC-3150)
For use with Voltmeters, Flow Meters and Passage Counters



- Products with this mark comply with EN12830, the European Standard regarding Temperature recorders for the transport, storage and distribution of chilled, frozen, deep-frozen/quick-frozen food and ice cream. (Excluding L Type)

- L-type models (model names which include " L ") are designed with a large capacity battery pack. Battery life of the L type is four times longer than that of the normal type.



Data Logger (with the rear cover and battery removed)



L Type

Meet Your Needs

Temperature / Humidity High Precision Wide Range



RTR-507S / RTR-507SL

Measurement Range:
 Temperature: -25 to 70°C
 Humidity: 0 to 99 %RH
 Attached Sensor:
 High Precision Temperature/Humidity Sensor (SHB-3101)

Temperature - Pt100 / Pt1000



RTR-505-Pt / RTR-505-PtL

Measurement Range: -199 to 600°C
 Attached Module:
 Input Module (PTM-3010)
 Sensor sold separately (For details about Pt sensors see the T&D Web Site)

Temperature - Thermocouple



RTR-505-TC / RTR-505-TCL

Measurement Range:
 K: -199 to 1370°C
 J: -199 to 1200°C
 T: -199 to 400°C
 S: -50 to 1760°C
 Attached Module: Input Module (TCM-3010)
 (Please purchase sensor separately)

Illuminance / UV Intensity / Temperature / Humidity



RTR-574 / RTR-574-S

S type comes with our high precision temp/humidity sensor.
 Measurement Range:
 Illuminance: 0 to 130,000 lx
 UV Intensity: 0 to 30 mW/cm²
 Temperature: 0 to 55°C (S: -25 to 70 °C)
 Humidity: 10 to 95 %RH (S: 0 to 99 %RH)
 Display Range of Cumulative Measurement
 Illuminance: 0 lxh to 90 Mlxh
 UV Intensity: 0 mW to 62 W/cm²h
 Attached Sensor:
 Illuminance UV Sensor ISA-3151
 Temperature / Humidity Sensor THA-3151 (S: High Precision Temp/Humidity Sensor SHA-3151)

CO2 / Temperature / Humidity



RTR-576 / RTR-576-S

S type comes with our high precision temp/humidity sensor.
 Measurement Range:
 CO2 Concentration: 0 to 9,999 ppm
 Temperature: 0 to 55°C (S: -25 to 70°C)
 Humidity: 10 to 95 %RH (S: 0 to 99 %RH)
 Attached Sensor
 CO2 Sensor: NDIR type
 Temperature / Humidity Sensor THA-3001 (S: High Precision Temperature/ Humidity Sensor SHA-3151)

Base Unit equipped with Mobile Network Capabilities

Mobile Base Station RTR-500MBS-A

RTR-500MBS-A

- ▶ Increased communication speeds and lower monthly costs
- ▶ All data loggers in the RTR-500 Series are supported

"Mobile" makes it possible to...

- ▶ Gather recorded data and monitor for warnings even in environments where network or PCs are not available.
- ▶ Check data from your smart phone or mobile device
- ▶ Get GPS location Info

Number of Possible Registrations (One Base)

Remote Units: Up to 20

(For RTR-574 and RTR-576, registration of one unit will be counted as two units.)

Repeaters: Up to 5 units per Group

Number of Groups : Up to 4 Groups

Application Examples

- Monitoring and Recording Temperature, Humidity and Location of Goods while in Transport
- Monitoring and Recording Temperature and Humidity in Distant Places where LAN Connection is Impossible
- Monitoring and Recording Temperature and Humidity in Buildings or Environments where LAN Connections are not Possible or not Desirable.



T&D Web Storage Compatible (see p.11)

Coverage to Areas where LAN Connection is Difficult



On-Site Warnings & Alert Notifications to Mobile Devices

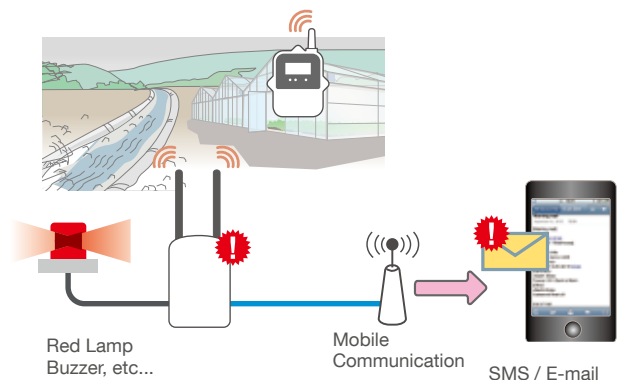

Easy Data Collection, Easy Graph Display, No Computer Necessary

Portable Data Collector - RTR-500DC

- ▶ From the RTR-500DC it is possible via wireless communication to make recording interval settings, and collect and save data.
- ▶ Includes a monitoring function whereby at a set interval the Collector communicates with data loggers and gathers current readings.
- ▶ An alarm buzzer sounds when a warning occurs.
- ▶ On the spot graphical viewing of recorded data.

Number of Possible Registrations (One Base)

Remote Units: Up to 32 units per Group
(For RTR-505, RTR-574, and RTR-576, registration of one unit will be counted as two units.)
Repeaters: Up to 15 units per Group
Number of Groups : Up to 7 Groups



Application Examples

- For Collecting Recorded Data and Monitoring Current Readings of Products while Moving on Production Lines
- For Collecting Recorded Data and Monitoring Current Readings of Packages in Cargo Compartments from a Truck's Cabin
- For Collecting Recorded Data at Construction Sites and other Places where PCs are not Available

On-Site Monitoring



```

WL Monitor Mode bY.n
REC P1M GROUP: Group1
FULL NAME: Unit02
69.9 30.0 [°F]
38.0 10.0 [°F]
        60.0 [°F]
        20.0 [%RH]
    
```

Anywhere Data Access

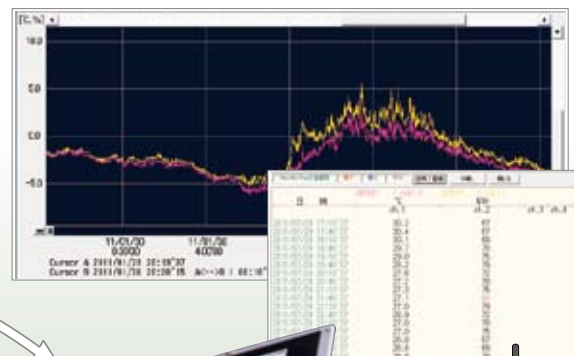

Download data via
USB connection

Network Base Station - RTR-500NW (for wired LAN) / RTR-500AW (for wireless LAN - 802.11 b/g)

- ▶ The system is designed to allow for the automatic sending of recorded data to an e-mail or FTP server without the need for a PC.
- ▶ Current readings can be monitored via in-company LAN.
- ▶ Registering with our "T&D WebStorage Service" makes it possible to view current readings on a PC or mobile device.
- ▶ The warning monitoring function with notification via e-mail or external contact ensures that important warnings are never missed by those nearby or far away.
- ▶ Being able to make and change settings via a network provides increased flexibility.

Number of Possible Registrations (One Base)

Remote Units: Up to 100

(For RTR-574 and RTR-576, registration of one unit will be counted as two units.)

Repeaters: Up to 10 units per Group

Number of Groups : Up to 10 Groups



T&D Web Storage Compatible (see p.11)

Application Examples

- For Monitoring Temperature in Refrigerators and Freezers
- For Monitoring and Recording of Temperature, Humidity and Instrumentation Signals in Factories, Warehouses and other Building Facilities
- For Managing Temperature and Humidity in Server Rooms

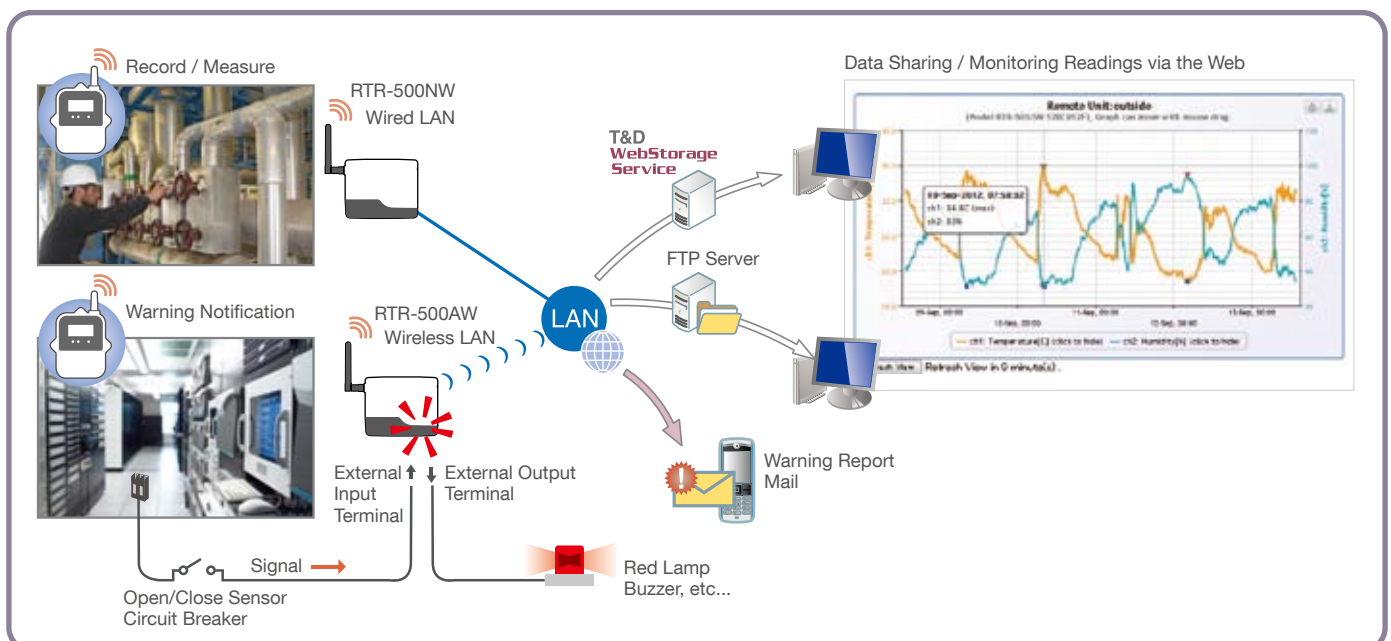

Wireless Base Station - RTR-500

- ▣ This system allows for the automatic collection of recorded data by simply connecting to a PC via USB.
- ▣ It is possible to check current readings and warning occurrences on the PC monitor or by e-mail.
- ▣ By using the supplied software, recorded data can easily be sent to an e-mail or FTP server.
- ▣ All Base Units can be set up to act as Repeaters.



T&D Web Storage Compatible (see p.11)

Number of Possible Registrations (One Base)

Remote Units: Up to 32 units per Group
(For RTR-574 and RTR-576, registration of one unit will be counted as two units.)
Repeaters: Up to 30 units per Group
Number of Groups : Up to 20 Groups

Application Examples

- For Temperature and Humidity Management in Blood and Pharmaceutical Storage
- For Temperature Management of Refrigerated and Frozen Goods at Supermarkets and Convenience Stores
- For Preservation and Prevention of Deterioration of Exhibits in Museums and other Exhibit Forums

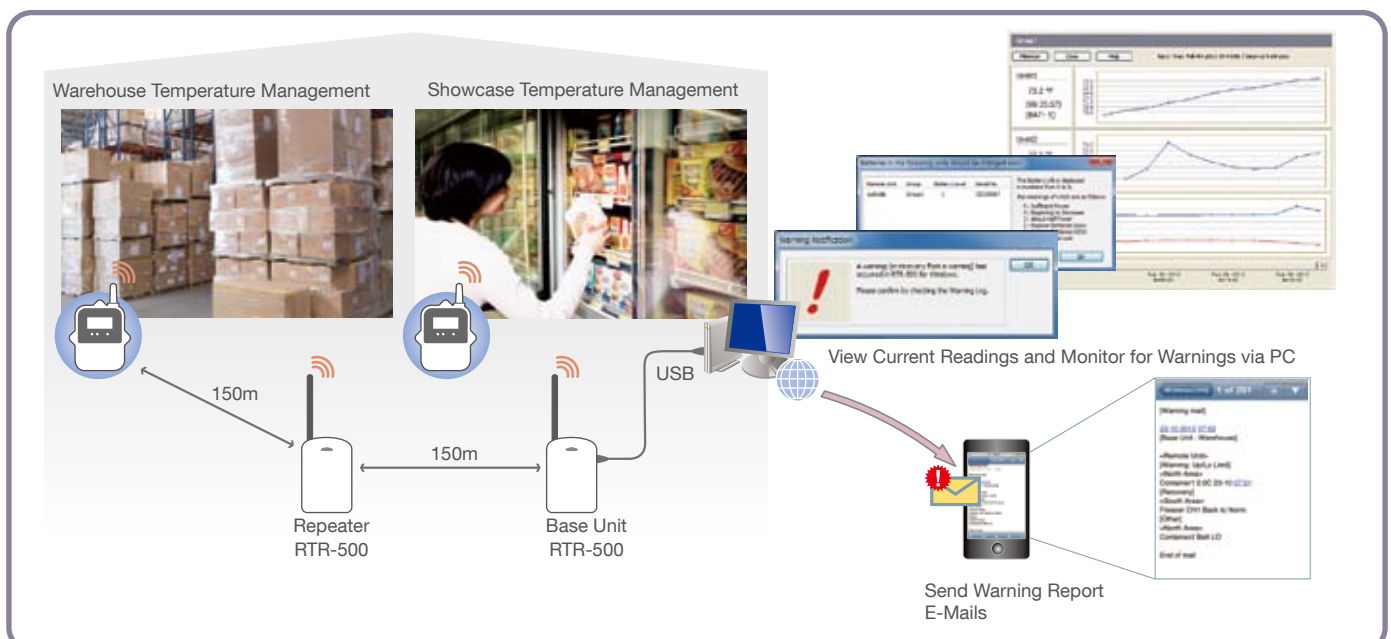

Empowering Auto-Monitoring Functions

Never Miss Warning Notification System

Variety of Warning Notifications provides Reliable Oversight

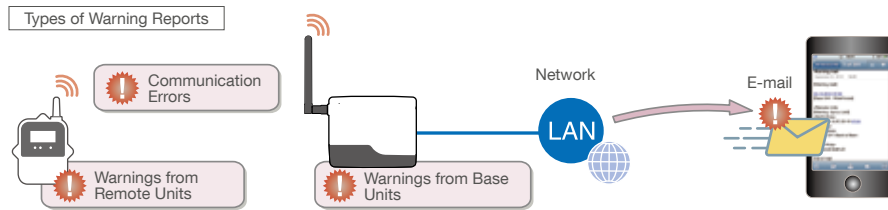

Warnings from Remote Units	RTR-500MBS-A	RTR-500NW RTR-500AW	RTR-500	RTR-500DC
Upper Limit / Lower Limit Exceeded Settings can be made in each Remote Unit for "Upper and/or Lower Limits" and well as for "Judgement Time". This ensures that every instantaneous exceeding is not counted as a warning.				
Sensor Error This type of notification helps prevent loss of measurements due to sensor disconnection, malfunction or wire breakage.				
Remote Unit Battery Level This notifies the user that battery level is low before wireless communication can no longer be carried out.				-
Warnings from Base Units				
Contact Input ON It is possible to connect to an external device which has a warning output terminal to notify when a warning has occurred and the contact switches ON.			-	-
Recovery from Warning Status This notifies the user when recovery from a warning has occurred; saving time and effort.				-
Communication Error Warnings				
Wireless Communication Failures This notifies the user that wireless communication has repeatedly failed.				-

Range of Notification Tools means "No Miss" Management

By E-mail / SMS

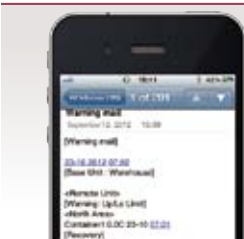

Note: SMS can only be used with RTR-500MBS-A.

With an External Alarm Device

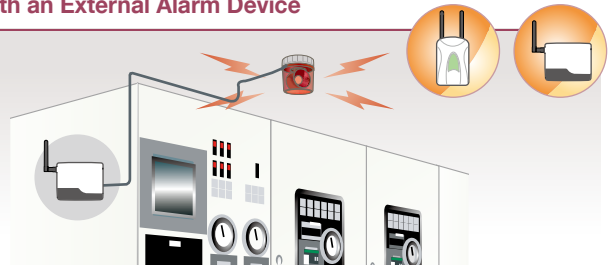

On a PC

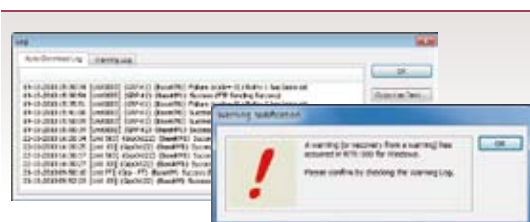

On a Data Collector



Monitor Measurement Readings from Any Location

Auto-Display of Current Readings at Set Interval

Via the Software

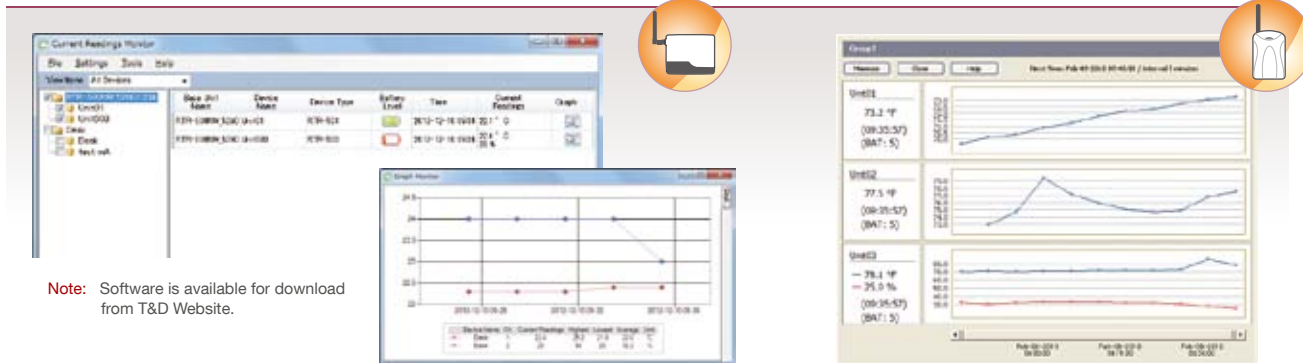

Note: Software is available for download from T&D Website.

Measurement readings can be monitored using the dedicated software installed on the PC.

On a Data Collector

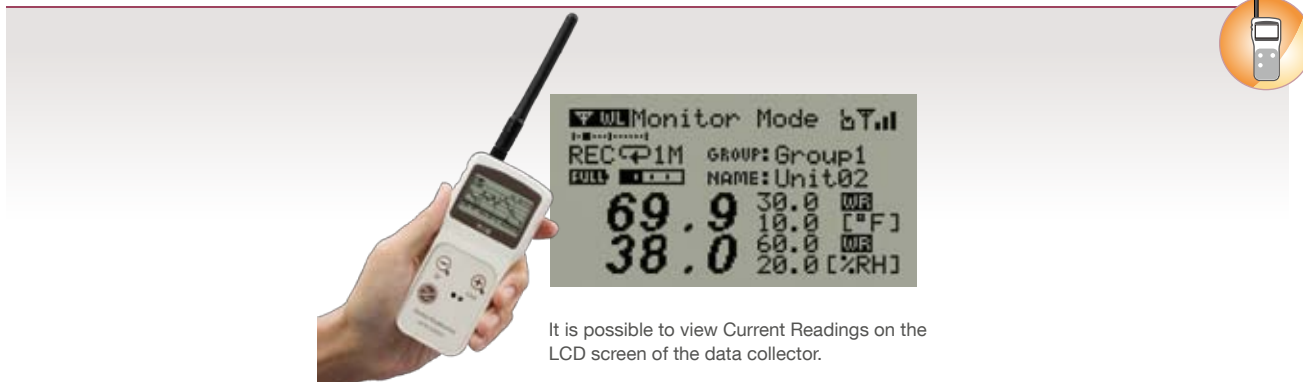

It is possible to view Current Readings on the LCD screen of the data collector.

Via a Web Browser

Access Anytime Anywhere

T&D WebStorage Service



<http://www.webstorage-service.com/>

"T&D Web Storage" is a free web-based storage service provided by T&D Corporation. By sending downloaded recorded data to "T&D Web Storage", it is possible to access your important data from anywhere in the world at any time you wish.



Registration is required to use T&D WebStorage Service.

Temperature Sensors for RTR-502 / 502L

Measurement Range: -60 to 155°C,
 Sensor Temperature Durability: -70 to 180°C
 Accuracy (TR-5620 excluded): Avg. ± 0.3°C at -20 to 80°C, Avg. ± 0.5°C at -40 to -20°C / 80 to 110°C, Avg. ± 1.0°C at -60 to -40°C / 110 to 155°C
 Materials: ① Thermistor ② Stainless Tube (SUS316) ③ FEP Shrink Tube ④ FEP Cable ⑤ Fluoropolymer Mold

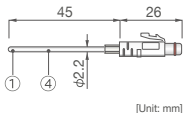
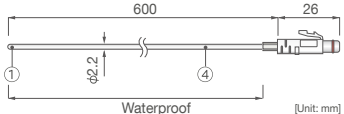
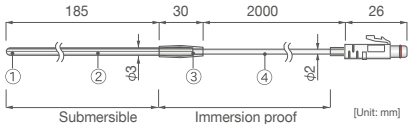
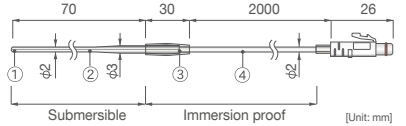
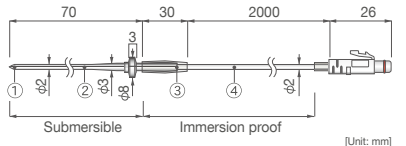
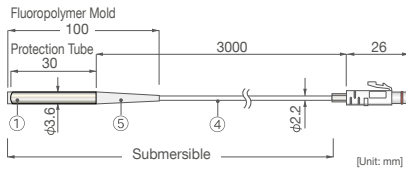
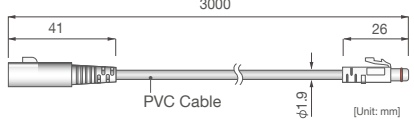
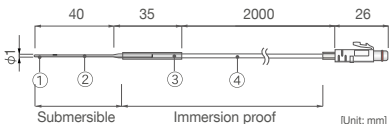
<p>Fluoropolymer Coated Sensor</p> <p>TR-5101 Response Time (90%): Approx. 80 sec. (in air)</p>  <p>[Unit: mm]</p> <p>TR-5106 Response Time (90%): Approx. 80 sec. (in air) Approx. 7 sec. (in agitated water)</p>  <p>[Unit: mm]</p>	<p>Stainless Protection Sensor</p> <p>TR-5220 Response Time (90%): Approx. 150 sec. (in air) Approx. 7 sec. (in agitated water)</p>  <p>[Unit: mm]</p> <p>TR-5320 Response Time (90%): Approx. 90 sec. (in air) Approx. 3 sec. (in agitated water)</p>  <p>[Unit: mm]</p> <p>TR-5420 Response Time (90%): Approx. 90 sec. (in air) Approx. 3 sec. (in agitated water)</p>  <p>[Unit: mm]</p>
<p>Underwater Sensor</p> <p>TR-5530 Response Time (90%): Approx. 150 sec. (in air) Approx. 15 sec. (in agitated water)</p>  <p>[Unit: mm]</p>	<p>Temperature Sensor Extension Cable for RTR-502 / 502L</p> <p>TR-2C30 Waterproof Capacity: Splash proof (rated for use in daily life) Temperature Durability: -25 to 60°C</p>  <p>[Unit: mm]</p>
<p>High Sensitivity Ultra-thin Sensor</p> <p>TR-5620 Accuracy Avg. ±0.5°C at -20 to 60°C Avg. ±1.0°C at -60 to -20°C, 60 to 80°C Avg. ±2.0°C at 80 to 155°C Response Time (90%): Approx. 50 sec. (in air) Approx. 1 sec. (in agitated water)</p>  <p>[Unit: mm]</p>	<p>Note: Only one extension cable per sensor.</p>

Temperature / Humidity Sensor for RTR-503 / 503L

TR-3310
 Measurement Range * :
 Temperature: 0 to 55°C
 Humidity: 10 to 95 %RH
 Accuracy:
 Temperature: Avg.± 0.3°C
 Humidity: ±5%RH (at 25°C, 50%RH)
 Response Time (90%): Approx. 7 min.
 Temperature Durability: -10 to 60 °C

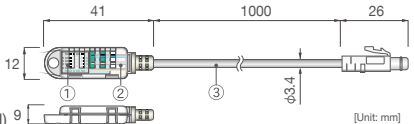

[Unit: mm]

* Do not expose to condensation, dampness, corrosive gases or organic solvents.
 Materials: ① Temp/Humidity Sensor ② Polypropylene Resin ③ PVC Cable

High Precision Temperature / Humidity Sensor for RTR-507S / 507SL

SHB-3101
 Measurement Range:
 Temperature: -25 to 70 °C
 Humidity:
 0 to 99 %RH at 0 to 60 °C
 Measurement Resolution:
 Temperature: 0.1°C
 Humidity: 0.1 %RH
 Accuracy (Temperature):
 ±0.3°C at 10 to 40 °C
 ±0.5°C at all other temperatures
 Accuracy (Humidity):
 ±2.5 %RH at 15 to 35 °C, 30 to 80 %RH
 Response Time (90%): 7 min.
 Long Term Stability: ±1%RH/yr, ±0.1°C/yr *

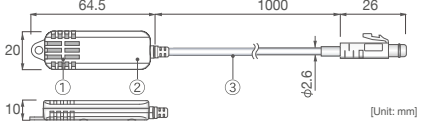

[Unit: mm]

Materials: ① Temp/Humidity Sensor ② ABS Resin ③ Halogen-Free Flame Resistant Seath Cable
 * Do not expose to condensation, dampness, corrosive gases, organic solvents.

Temp/Humidity Sensor Extension Cable for RTR-507S / 507SL

TR-3C30
 Waterproof Capacity: Splash proof
 (rated for use in daily life)
 Temperature Durability: -25 to 60 °C

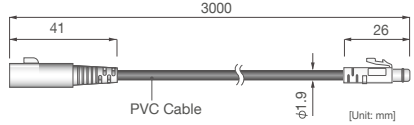

[Unit: mm]

Note: Only one extension cable per Temp/Humidity sensor.

Input Modules for RTR-505 / 505L

Materials: ① Polycarbonate ② PVC Cable
Note: Input Module is not water resistant.

Thermocouple Module (RTR-505-TC / 505-TCL)

TCM-3010

Compatible Sensors:
 Thermocouple: Type K, J, T, S
 Sensor Connection:
 Miniature Thermocouple Connector
 Operating Environment:
 Temperature: -40 to 80°C
 Humidity: 90%RH or less (no condensation)

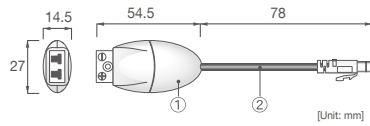

Pt Module (RTR-505-Pt / 505-PtL)

PTM-3010

Compatible Sensors:
 Pt100 (3-wire, 4-wire),
 Pt1000 (3-wire, 4-wire)
 In the case of a 4-wire sensor, one wire will be left unused.
 Sensor Connection:
 Screw Clamp Terminal Block: 3-Terminal
 Square Washer (3-M3.5)
 Operating Environment:
 Temperature: -40 to 80°C
 Humidity: 90%RH or less (no condensation)

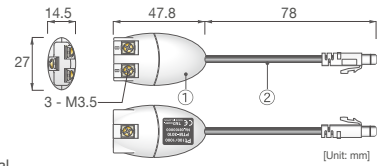

4-20mA Module (RTR-505-mA / 505-mAL)

AIM-3010

Measurement Range:
 0 to 20mA (Operational up to 40 mA)
 Accuracy:
 ±0.05 mA + 0.3 % of reading
 (10 to 40 °C)
 Operating Environment:
 Temperature: -40 to 80°C
 Humidity: 90%RH or less (no condensation)

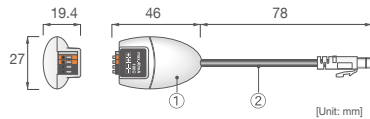

Pulse Input Cable (RTR-505-P / 505-PL)

PIC-3150

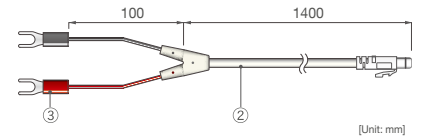

Voltage Module (RTR-505-V / 505-VL)

VIM-3010

Measurement Range: 0 to 22 V
 Accuracy:
 ±0.5 mV + 0.3 % of reading
 (10 to 40 °C)
 Measurement Resolution:
 Minimum of 0.1mV
 Preheat Function: 3V to 20V, 100mA
 Operating Environment:
 Temperature: -40 to 80°C
 Humidity: 90%RH or less (no condensation)

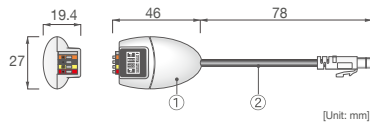

Input Module Extension Cable

TR-3C30

Waterproof Capacity:
 Splash proof
 (rated for use in daily life)
 Temperature Durability:
 -25 to 60 °C

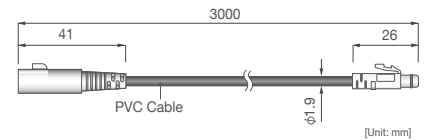

Note: Only one extension cable per input module.

Pt100 Sensor for RTR-505-Pt / 505-PtL

TR-81## - #.# - ##### - ##M



- A:** Sensor Type (2 digits)
- B:** Protection Tube Diameter (2 digits)
- C:** Protection Tube Length (2 - 4 digits)
- D:** Cable Length (1 - 2 digits)

To order, create the model number by selecting **A**, **B**, **C**, **D** (See below).
 Pt100 Sensors are produced only upon receipt of order; therefore please allow three weeks from the time of order until shipping.

Sensor Specification

Sensor Device	Pt100	Range of Error	± (0.15 + 0.002 × t) °C (t = absolute value of measurement)
Electrical Current	less than 2mA	Insulation Resistance	DC500V over 10MΩ
Conductor	3 wire type	Water Resistance	None (only stainless protection tube is wter resistant)

A Sensor Type

TR-8100 (Economical Type)

Measurement Range: -50 to 200 °C
 Thermal Constant Time:
 Approx. 4.5 sec. * (in agitated water)

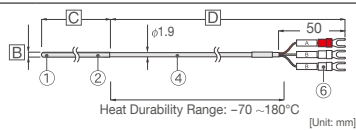

TR-8110 (Regular Type)

Measurement Range: -200 to 350 °C
 Thermal Constant Time:
 Approx. 2 sec. * (in agitated water)

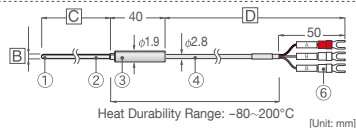

TR-8120 (Low to High Temp Type)

Measurement Range: -200 to 600°C
 Thermal Constant Time:
 Approx. 2 sec. * (in agitated water)

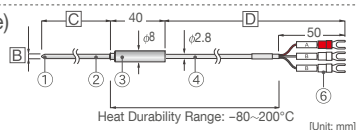

TR-8130 (Handy Type)

Measurement Range: -50 to 200 °C
 Thermal Constant Time:
 Approx. 2.5 sec. * (in agitated water)

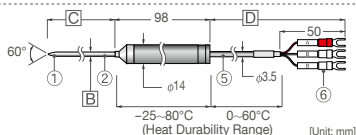

* Stated thermal constant time is for sensors with a protection tube diameter of φ3.2.

Materials: ① Sensor (Pt100), ② Stainless Protection Tube (SUS316), ③ Sleeve (SUS304), ④ FEP Cable, ⑤ PVC Cable, ⑥ Crimp Terminals

B Protection Tube Diameter

	TR-8100	TR-8110	TR-8120	TR-8130
φ 2.0	-	○	-	-
φ 2.3	○	○	-	-
φ 3.0	○	○	-	-
φ 3.2	◎	◎	◎	◎
φ 4.8	○	○	○	○
φ 6.0	○	○	-	-
φ 6.4	-	-	○	-

◎ Recommended ○ Available - Not available

C Protection Tube Length

The protection Tube is available in 50 millimeter units in lengths from 50mm to 2000mm.

D Sensor Cable Length

The sensor cable is available in 1 meter units in lengths from 1 meter to 99 meters.

Sensor Model Number Examples:

- EX1: Economical type with 2.3mm diameter x 50mm sheath with 1m of cable:
 Model Number: TR-8100-2.3-50-1M
- EX2: Low to high temp type with 3.2mm diameter x 200 mm sheath with 5m of cable:
 Model Number: TR-8120-3.2-200-5M

Sensors for RTR-574 / 576

Note: Do not expose to condensation, dampness, corrosive gases, or organic solvents.

Temperature / Humidity Sensor

THA-3001

Measurement Range :
 Temperature: 0 to 55 °C
 Humidity: 10 to 95 %RH (no condensation)
 Measurement Accuracy:
 Temperature: ±0.5 °C
 Humidity: ±5%RH at 25°C and 50%RH
 Response Time (90%): Approx. 7 min.

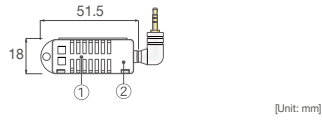

[Unit: mm]

Materials: ① Temp/Humidity Sensor ② Polypropylene Resin

High Precision Temperature / Humidity Sensor

SHA-3151

Measurement Range:
 Temperature: -25 to 70 °C
 Humidity: 0 to 99 %RH at 0 to 60 °C
 Measurement Resolution:
 Temperature: 0.1 °C
 Humidity: 0.1 %RH
 Accuracy (Temperature):
 ±0.3°C at 10 to 40 °C
 ±0.5°C at all other temperatures
 Accuracy (Humidity):
 ±2.5 %RH at 15 to 35 °C, 30 to 80 %RH
 Response Time (90%): Approx. 7 min.
 Long Term Stability: ±1%RH/yr, ±0.1°C/yr

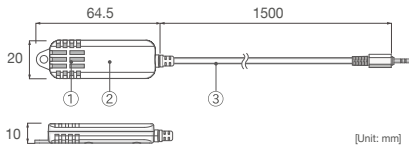

[Unit: mm]

Materials: ① Temp/Humidity Sensor ② ABS Resin ③ Halogen-Free Flame Resistant Sheath Cable

Serial Communication Cable (RTR-574 / 576)

TR-6C10

For communication between RTR-500DC and RTR-574 / 576 (including S type)

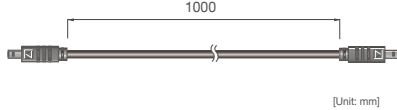

[Unit: mm]

Temperature / Humidity Sensor

THA-3151

Measurement Range :
 Temperature: 0 to 55 °C
 Humidity: 10 to 95%RH (No condensation)
 Measurement Resolution:
 Temperature: 0.1 °C
 Humidity: 1 %RH
 Accuracy:
 Temperature: ±0.5 °C
 Humidity: ±5%RH at 25 °C and 50%RH
 Response Time (90%): Approx. 7 min.

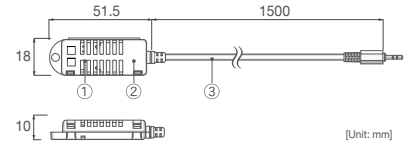

[Unit: mm]

Materials: ① Temp/Humidity Sensor ② Polypropylene Resin ③ Vinyl Chloride Coated Electrical Wire

Illuminance / UV Sensor (RTR-574)

ISA-3151

Measurement Range:
 Illuminance: 0 lx to 130 klx
 UV Intensity: 0 to 30 mW/cm²
 Measurement Resolution:
 Illuminance: Minimum of 0.01 lx
 UV Intensity: Minimum of 0.001 mW/cm²
 Accuracy:
 Illuminance 10 lx to 100 klx: ±5% at 25°C, 50%RH
 UV Intensity 0.1 to 30 mW/cm²: ±5% at 25°C, 50%RH *
 Relative Spectral Response:
 Illuminance: Approximated to the CIE standard response function V (λ).
 UV Intensity: 260 to 400 nm (UVA / UVB)
 Operating Environment : Temperature: -10 to 60 °C
 Humidity: ±90%RH or lower

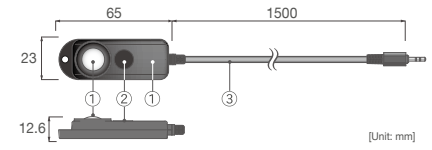

[Unit: mm]

Materials: ① Polycarbonate ② Glass ③ PVC Cable

* Compared to the value measured by the T&D standard sensor for calibration under our calibration light source.

Sensor Extension Cable (RTR-574 / 576)

TR-1C30

Temperature Durability: -25 to 60 °C (including S type)



[Unit: mm]

Materials: ① PVC Cable

Note: Temp-Humidity sensors and Illuminance-UV sensors can use up to 9 meters of extension cables.

Serial Communication Cable (RTR-500 / RTR-500DC)

TR-07C

For Communication with the Computer

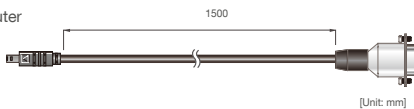

[Unit: mm]

External Power Cable (RTR-500MBS-A)

BC-0302

Power Source Conditions:
 Voltage: DC 10 - 24 V
 Current: MAX 2A

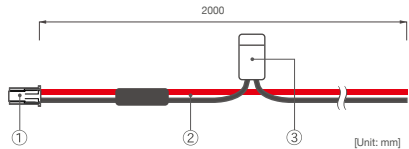

[Unit: mm]

Materials: ① Connector: Housing/ XAP-02V-1, Contact/ SXA-01T-P0.6 (J.S.T. Mfg. Co., Ltd.)
 ② Cable: AWG#20, Red/ Plus (+), Black/ Minus (-)
 ③ Flat mini-fuse: 2A / 32V

AC Adaptors

RTR-500NW / 500AW / 500 / 500DC, RTR-576

AD-06A1(FCC)

Cable Length: 1.8 m
 Input: AC 100 - 240 V
 Output: DC 6 V 500 mA
 Frequency: 50 / 60 Hz
 Plug Type : A

AD-06C1(CE)

Cable Length: 1.8m
 Input: AC 100-240V
 Output: DC 6V 1.0A
 Frequency: 50 / 60Hz
 Plug Type: C



RTR-500MBS-A

AD-05A3(FCC)

Cable Length: 1.2 m
 Input: AC100 - 240V
 Output: DC 5V 2A
 Frequency: 50 / 60 Hz
 Plug Type : A

AD-05C1(CE)

Cable Length: 1.6 m
 Input: AC100 - 240V
 Output: DC 5 V 2 A
 Frequency: 50 / 60Hz
 Plug Type: C

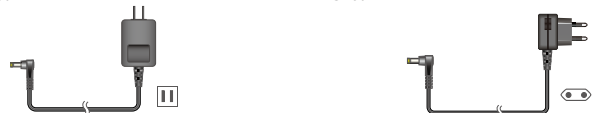

Other Options for RTR-501 / 502 / 503 / 505 / 507S

Maintenance Set

TR-00P1

- Included:
 Rubber Packing (for the rear cover of the data logger)
 Silica Gel (drying agent)
 Double-Sided Adhesive Tape (to fix the silica gel)
 Lock Screw (extra screws to tighten the rear cover of the data logger)

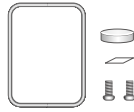

External Power Adaptor Kit

RTR-500A2

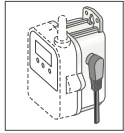

- Input Voltage: DC 6 V
 Backup Power:
 Ni-MH Battery (In case of power loss)
 Back-up Time: About 4 days *
 Charging Method: Trickle Charge
 Operational Environment Temp: 0 to 60°C
 Water Resistance: None
 Weight: About 37g (without AC Adaptor)
 Included:
 AC Adaptor (AD-06A1 or AD-06C1) ,
 Case,
 Rubber Packing , Lock Screw

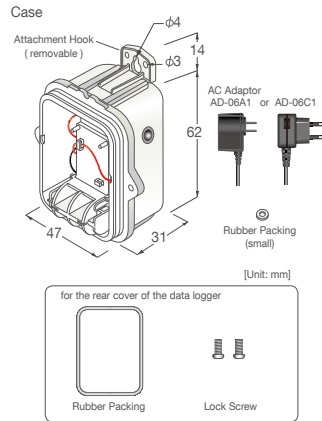

* Varies depending on the amount of charge in the Ni-MH battery.
Note: RTR-500A2 should not be used with the RTR-501.

Large Capacity Battery Kit

RTR-500B1

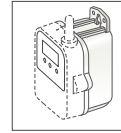

- Power: Lithium Battery x 1 (LS26500) (*1)
 Battery Life: about 4 years (*2)
 Waterproof Capability: Splash proof
 Operating Temperature: -40 to 80 °C (*3)
 Weight: about 75g (including Lithium Battery)
 Included:
 Maintenance Set TR-00P1,
 Case

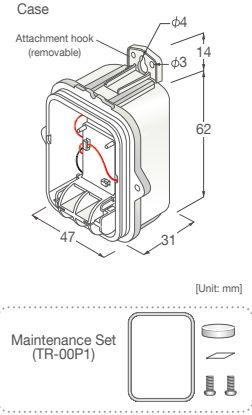

*1: When using RTR-500B1 it is necessary to purchase Lithium Battery (LS26500). For details, contact your local authorized distributor.
 *2: Battery Life varies depending on measuring environment, recording interval, transmission frequency, and ambient temperature. The battery life estimated here is calculated using a new battery under normal operating conditions and in no way should be understood as a guarantee of battery life.
 *3: Operating temperature depends on the specifications for the data logger being used.

Wall Attachment for Data Logger

TR-05K3 (RTR-501 / 502 / 503 / 505 / 507S)

- Included:
 Lock Screw x 2,
 Double-Sided Adhesive Tape x 1
 Operational Environment Temp:
 -40 to 80°C
 Materials: Polycarbonate

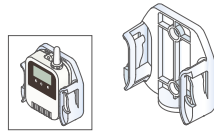

TR-05K3L (for L Types)

- Included:
 Lock Screw x 2,
 Double-Sided Adhesive Tape x 1
 Operational Environment Temp:
 -40 to 80°C
 Materials: Polycarbonate

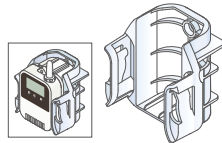

TR-07K2 (RTR-574 / 574-S)

- Included:
 Lock Screw x2,
 Double-Sided Adhesive Tape x 1
 Materials: Polycarbonate

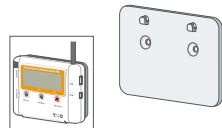

AT-76K1 (RTR-576 / 576-S)

- Included:
 Lock Screw x 2,
 Double-Sided Adhesive Tape x 1
 Materials: Aluminum

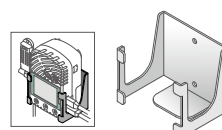

Note: Cracking may occur if polycarbonate is exposed to strong impact at temperatures of -30°C or lower.

Wall Attachment for Base Unit

TR-5GK1 (RTR-500MBS-A)

- Included:
 O-Ring (rubber) x 1
 Lock Screw x 2
 Double-Sided Adhesive Tape x 1
 Materials: Aluminum

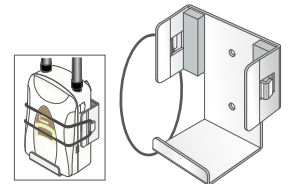

AT-50K1 (RTR-500)

- Included:
 O-Ring (rubber) x 1
 Lock Screw for fastening to wall x 2,
 Double-Sided Adhesive Tape x 1
 Materials: Aluminum

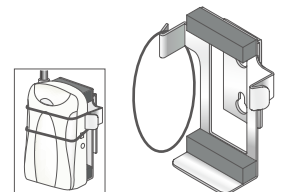

TR-5WK1 (RTR-500NW / 500AW)

- Included:
 Lock Screw for fastening to wall x 2,
 Double-Sided Adhesive Tape x 1,
 Lock Screw for fastening the device x 1
 Materials: Polycarbonate

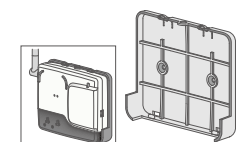

Note: Cracking may occur if polycarbonate is exposed to strong impact at temperatures of -30°C or lower.

RTR-500 Series - Specifications

Remote Units (Data Logger)						
	RTR-501 / 501L	RTR-502 / 502L	RTR-503 / 503L		RTR-507S / 507SL	
Measurement Channels	Temperature 1ch	Temperature 1ch	Temperature 1ch, Humidity 1ch		Temperature 1ch, Humidity 1ch (High Precision Type)	
Sensor	Thermistor (Internal)	Thermistor	Thermistor	Polymer Resistance	Thermistor	Polymer Resistance
Measurement Units	°C, °F	°C, °F	°C, °F	%RH	°C, °F	%RH
Measurement Range	-40 to 80 °C	-60 to 155 °C	0 to 55 °C	10 to 95 %RH	-25 to 70 °C	0 to 99 %RH (*1)
Accuracy	Avg.±0.5 °C	Avg.±0.3 °C at -20 to 80 °C Avg.±0.5 °C at -40 to -2 °C 80 to 110 °C Avg.±1.0 °C at -60 to -40 °C 110 to 155 °C	Avg.±0.3 °C	±5 %RH at 25 °C, 50 %RH	±0.3°C at 10 to 40 °C ±0.5°C all other temperatures	±2.5 %RH at 15 to 35 °C, 30 to 80 %RH
Measurement Resolution	0.1 °C	0.1 °C	0.1 °C	1 %RH	0.1 °C	0.1 %RH
Responsiveness	Thermal Time Constant: Approx. 15 min. Approx. 25 min. (L Type) Response Time (90%): Approx. 35 min. Approx. 47 min. (L Type)	Thermal Time Constant: Approx. 30 sec. (in air) Approx. 4 sec. (in agitated water) Response Time (90%): Approx. 80 sec. (in air) Approx. 7 sec. (in agitated water)	Response Time (90%): Approx. 7 min.		Response Time (90%): Approx. 7 min.	Response Time (90%): Approx. 20 sec.
Logging Capacity	16,000 readings		8,000 data sets (One data set consists of readings for multiple channels)			
Recording Interval	Select from 15 choices: 1, 2, 5, 10, 15, 20, 30 sec. or 1, 2, 5, 10, 15, 20, 30, 60 min.					
Recording Mode (*2)	Endless (Overwrite oldest data when capacity is full) or One Time (Stop recording when capacity is full)					
LCD Display Items	Measurements (alternating display for multiple channel devices), Battery Life Warning, etc.				Measurements (alternating display), Battery Life Warning, etc.	
Communication Interfaces	- Wireless Communication (Short Range Radio Communication) FCC Part15 Section247 / IC RSS-210 (Frequency Range: 902 to 928 MHz, RF Power: 7 mW) ETSI EN 300 220 (Frequency Range: 869.7 to 870 MHz, RF Power: 5 mW) - Optical Communication (proprietary protocol)					
Wireless Transmission Range	Approx. 150 meters (500 ft) if direct and unobstructed					
Power	Lithium Battery: LS14250 x 1 L Type: Large Capacity Battery Adaptor Kit (RTR-500B1) (*3) External Power Adaptor Kit (RTR-500A2: sold separately) (*4)					
Battery Life (*5)	About 10 months L Type: About 4 years					
Dimensions	H 62 mm x W 47 mm x D 19 mm L type: H 62 mm x W 47 mm x D 46.5 mm (excluding protrusions and sensor) Antenna length: 24 mm					
Weight	Approx. 50 g L Type: approx. 65 g					
Operating Environment	-40 to 80°C (-30 to 80°C during wireless communication)				-40 to 80°C (-10 to 80°C during wireless communication) (*6)	
Waterproof Capacity	IP67: Immersion proof	IP64: Splash proof (rated for use in daily life) (*7)	IP64: Splash proof (rated for use in daily life) (*7) Note: Sensor is not water resistant.		IP64: Splash proof (rated for use in daily life) (*7) Note: Sensor is not water resistant.	
Accessories	-	Temperature Sensor (TR-5106)	Temperature / Humidity Sensor (TR-3310)		Temperature / Humidity Sensor (SHB-3101)	
Compatible Base Units	RTR-500, RTR-500NW / 500AW, RTR-500DC, RTR-500MBS-A, RTR-500GSM				RTR-500, RTR-500NW / 500AW, RTR-500DC, RTR-500MBS-A	

*1: When continually used in environments with temperatures above 60°C, accuracy of humidity measurements will decrease over time. Also, humidity cannot be measured at temperatures below -20°C.

*2: Only "Endless" is available when using RTR-500W for Windows, RTR-500MBS for Windows or RTR-500GSM for Windows.

*3: When using RTR-500B1 it is necessary to purchase Lithium Battery (LS26500). For details, contact your local authorized distributor.

*4: RTR-500A2 should not be used with the RTR-501.

*5: Battery life varies depending upon the ambient temperature in which it is used, the recording interval, the frequency of communication, and the battery performance. All estimates are based on operations carried out with a new battery and are in no way a guarantee of actual battery life.

*6: When wireless communication is performed in an environment below -10°C, measurement may fail or may not be accurate.

*7: This is the waterproof capacity of the data logger with the sensor connected. Note that the temperature-humidity sensor is not water resistant.

The specifications listed above are subject to change without notice.

Remote Units (Data Logger)					
	RTR-505-TC / 505-TCL	RTR-505-Pt / 505-PtL	RTR-505-V / 505-VL	RTR-505-mA / 505-mAL	RTR-505-P / 505-PL
Measurement Channels	Temperature 1ch	Temperature 1ch	Voltage 1ch	4-20 mA 1ch	Pulse Count 1ch
Sensor	Thermocouple: Type K, J, T, S	Pt100, Pt1000 3-wire, 4-wire (*1)	-	-	-
Measurement Units	°C, °F	°C, °F	V, mV	mA	P
Measurement Range	K -199 to 1370 °C J -199 to 1200 °C T -199 to 400 °C S -50 to 1760 °C	-199 to 600 °C	0 to 22 V	0 to 20 mA (Operational up to 40 mA)	
Accuracy (*2)	Thermocouple Measurement K, J, T : ±(0.3°C+0.3% of reading) S : ±(1°C+0.3% of reading) Cold Junction Compensation ±0.3 °C at 10 to 40 °C ±0.5 °C at -40 to 10 °C, 40 to 80 °C	±(0.3 °C+0.3 % of reading) at 10 to 40 °C ±(0.5 °C+0.3 % of reading) at -40 to 10 °C, 40 to 80 °C	±(0.5 mV + 0.3% of reading) at 10 to 40 °C ±(1 mV+0.5% of reading) at -40 to 10 °C, 40 to 80 °C	±(0.5 mV + 0.3% of reading) at 10 to 40 °C ±(1 mV+0.5% of reading) at -40 to 10 °C, 40 to 80 °C	Input Signal: Non-voltage Contact Input Voltage Input (0 to 27 V) Detection Voltage: Lo: 0.5 V or less Hi: 2.5 V or more Input Impedance: Approx.100 KΩ pull up Chattering Filter: ON: 15 Hz or less OFF: 3.5 kHz or less Maximum Count: 61,439 / Recording Interval
Note: The temperature range shown above represents the operating environment of the Input Module.					
Measurement Resolution	K, J, T : 0.1 °C S : 0.2 °C	0.1 °C	Up to 400 mV : 0.1 mV Up to 800 mV : 0.2 mV Up to 999 mV : 0.4 mV Up to 3.2 V : 1 mV Up to 6.5 V : 2 mV Up to 9.999 V : 4 mV Up to 22 V : 10 mV	0.01 mA	
Logging Capacity	16,000 readings				
Recording Interval	Select from 15 choices: 1, 2, 5, 10, 15, 20, 30 sec. or 1, 2, 5, 10, 15, 20, 30, 60 min.				
Recording Mode (*3)	Endless (Overwrite oldest data when capacity is full) or One Time (Stop recording when capacity is full)				
LCD Display Items	Measurements, Battery Life Warning, etc.				
Communication Interfaces	- Wireless Communication (Short Range Radio Communication) FCC Part15 Section 247 / IC RSS-210 (Frequency Range: 902 to 928 MHz, RF Power: 7 mW) ETSI EN 300 220 (Frequency Range: 869.7 to 870 MHz, RF Power: 5 mW) - Optical Communication (proprietary protocol)				
Wireless Transmission Range	Approx. 150 meters (500 ft) if direct and unobstructed				
Power	Lithium Battery LS14250 x 1 L Type: Large Capacity Battery Adaptor Kit RTR-500B1 (*4) External Power Adaptor Kit RTR-500A2				
Battery Life (*5)	About 10 months L Type: About 4 years				
Dimensions	H 62 mm x W 47 mm x D 19 mm L type: H 62 mm x W 47 mm x D 46.5 mm (excluding protrusions and Input Module) Antenna length: 24 mm				
Weight	Approx. 50 g L Type: approx. 65 g				
Operating Environment	-40 to 80 °C (-30 to 80°C during wireless communication)				
Waterproof Capacity (*6)	IP64: Splash proof (rated for use in daily life) Note: Input Module is not water resistant.				
Accessories	Input Module TCM-3010	Input Module PTM-3010	Input Module VIM-3010	Input Module AIM-3010	Input Module PIC-3150
Compatible Base Units	Lithium Battery LS14250 or Large Capacity Battery Adaptor Kit RTR-500B1, Strap (Not included with L type models), Manual (Warranty included)				
	RTR-500, RTR-500NW/500AW, RTR-500DC, RTR-500MBS-A				

*1: In the case of a 4-wire sensor, one wire will be left unused.

*2: For RTR-505-TC and RTR-505-Pt, sensor inaccuracies are not included.

*3: Only "Endless" is available when using RTR-500W for Windows or RTR-500MBS for Windows.

*4: When using RTR-500B1 it is necessary to purchase Lithium Battery (LS26500). For details, contact your local authorized distributor.

*5: Battery life varies depending upon multiple factors including ambient temperature, recording interval, frequency of communication, and battery performance. All estimates are based on operations carried out with a new battery and are in no way a guarantee of actual battery life.

*6: This is the waterproof capacity of the data logger with the Input Module connected. The Input Module itself is not water resistant.

The specifications listed above are subject to change without notice.

RTR-500 Series - Specifications

Remote Units (Data Logger)				
	RTR-574		RTR-574-S	
	Illuminance-UV Sensor			
Sensor	ISA-3151			
Measurement Channels	Illuminance: 1ch UV Intensity: 1ch			
Units of Measurement	Illuminance: lx, klx UV Intensity: mW/cm ²			
Measurement Range	Illuminance: 0 lx to 130 klx UV Intensity: 0 to 30 mW/cm ²			
Units of Cumulative Measurement	Cumulative Illuminance: lxh, klxh, Mlxh Cumulative amount of UV Light: mW/cm ² h, W/cm ² h			
Display Range of Cumulative Measurement	Illuminance: 0 lxh to 90 Mlxh UV Intensity: 0 mW to 62 W/cm ² h			
Accuracy	Illuminance: 10 lx to 100 klx: ±5 % at 25 °C, 50 %RH UV Intensity: 0.1 to 30 mW/cm ² : ±5 % at 25 °C, 50 %RH (*1)			
Relative Spectral Response	Illuminance: Approximated to the CIE standard response function V (λ) UV Intensity: 260 to 400 nm (UVA / UVB)			
Measurement Resolution	Illuminance: Minimum of 0.01 lx UV Intensity: Minimum of 0.001 mW/cm ²			
Responsiveness	Response Time (90%): 3 sec. at recording interval of 1 sec. 6 sec. at other intervals			
	Temperature/Humidity Sensor			
	THA-3151		SHA-3151 (High-Precision Type)	
Sensor	Thermistor	Polymer Resistance	Thermistor	Polymer Resistance
Measurement Channels	Temperature 1ch	Humidity 1ch	Temperature 1ch	Humidity 1ch
Units of Measurement	°C, °F	%RH	°C, °F	%RH
Measurement Range	0 to 55 °C	10 to 95 %RH	-25 to 70 °C	0 to 99 %RH (*2)
Accuracy	±0.5 °C	± 5 %RH at 25 °C, 50 %RH	±0.3°C at 10 to 40 °C ±0.5°C at all other temperatures	±2.5 %RH at 15 to 35 °C, 30 to 80 %RH
Measurement Resolution	0.1 °C	1 %RH	0.1 °C	0.1 %RH
Responsiveness	Response Time (90%): Approx. 7 min.		Response Time (90%): Approx. 7 min.	
Logging Capacity	8,000 data sets (One data set consists of readings for all channels in that type of unit.)			
Recording Interval	Select from 15 choices: 1, 2, 5, 10, 15, 20, 30 sec. or 1, 2, 5, 10, 15, 20, 30, 60 min.			
Recording Mode (*3)	Endless (Overwrite oldest data when capacity is full) or One Time (Stop recording when capacity is full)			
LCD Display Items	Measurements, Battery Life Warning, etc. - Measurements: Illuminance / UV Intensity / Temperature / Humidity / Cumulative Illuminance / Cumulative amount of UV Light - Display Pattern: Alternating or Fixed display - Display Digits: Up to 4 digits			
Communication Interfaces	- Wireless Communication (Short Range Radio Communication) FCC Part15 Section247 / IC RSS-210 (Frequency Range: 902 to 928 MHz, RF Power: 7 mW) ETSI EN 300 220 (Frequency Range: 869.7 to 870 MHz, RF Power: 5 mW) - USB Communication - Serial Communication (RS-232C) (*4)			
Wireless Transmission Range	Approx. 150 meters (500 ft) if direct and unobstructed			
Power	AA Alkaline Battery x1			
Battery Life (*5)	Approx. 4 months			
Dimensions	H 55 mm x W 78 mm x D 18 mm (excluding protrusions) Antenna Length: 60 mm			
Weight	Approx. 45 g			
Operating Environment	Temperature: -10 to 60 °C Humidity: 90 %RH or less (no condensation)			
Accessories	Temperature / Humidity Sensor THA-3151		Temperature / Humidity Sensor SHA-3151	
Compatible Base Units	AA Alkaline Battery LR6, USB Mini-B Cable US-15C, Illuminance-UV Sensor ISA-3151, Manual (Warranty Included)			
	RTR-500, RTR-500NW/500AW, RTR-500DC, RTR-500MBS-A			

*1: Compared to the value measured by the T&D standard sensor for calibration under our calibration light source.

*2: When continually used in environments with temperatures above 60°C, accuracy of humidity measurements will decrease over time. Also, humidity cannot be measured at temperatures below -20°C.

*3: Only "Endless" is available when using RTR-500W for Windows or RTR-500MBS for Windows.

*4: For communication with the Data Collector RTR-500DC (Note: Optional serial communication cable TR-6C10 is required.)

*5: Battery life varies depending upon the ambient temperature in which it is used, the recording interval, the frequency of communication, and the battery performance. All estimates are based on operations carried out with a new battery and are in no way a guarantee of actual battery life.

The specifications listed above are subject to change without notice.

Remote Units (Data Logger)				
	RTR-576		RTR-576-S	
	CO2 Sensor (Internal)			
CO2 Sensor (Internal)	NDIR			
Measurement Channels	CO2 Concentration 1ch			
Units of Measurement	ppm			
Measurement Range	0 to 9,999 ppm			
Accuracy	$\pm(50 \text{ ppm} + 5 \% \text{ of reading})$ at 5,000 ppm or less (*1)			
Measurement Resolution	Minimum of 1 ppm			
	Temperature/Humidity Sensor			
Temperature/Humidity Sensor (External)	THA-3001		SHA-3151 (High-Precision Type)	
	Thermistor	Polymer Resistance	Thermistor	Polymer Resistance
Measurement Channels	Temperature 1ch	Humidity 1ch	Temperature 1ch	Humidity 1ch
Units of Measurement	°C, °F	%RH	°C, °F	%RH
Measurement Range (*2)	0 to 55 °C	10 to 95 %RH	-25 to 70 °C	0 to 99 %RH (*3)
Accuracy	± 0.5 °C	± 5 %RH at 25 °C, 50 %RH	± 0.3 °C at 10 to 40 °C ± 0.5 °C at all other temperatures	± 2.5 %RH at 15 to 35 °C, 30 to 80 %RH
Measurement Resolution	0.1 °C	1 %RH	0.1 °C	0.1 %RH
Responsiveness	Response Time (90%): Approx. 7 min.		Response Time (90%): Approx. 7 min.	
Logging Capacity	8,000 data sets (One data set consists of readings for all channels in that type of unit.)			
Recording Interval	Select from 15 choices: 1, 2, 5, 10, 15, 20, 30 sec. or 1, 2, 5, 10, 15, 20, 30, 60 min.			
Recording Mode (*4)	Endless (Overwrite oldest data when capacity is full) or One Time (Stop recording when capacity is full)			
LCD Display Items	Measurements, Battery Level, etc. - Measurements: CO2 concentration, Temperature or Humidity (fixed or alternating display)			
Communication Interfaces	- Wireless Communication (Short Range Radio Communication) FCC Part15 Section 247 / IC RSS-210 (Frequency Range: 902 to 928 MHz, RF Power: 7 mW) ETSI EN 300 220 (Frequency Range: 869.7 to 870 MHz, RF Power: 5 mW) - USB Communication - Serial Communication (RS-232C) (*5)			
Wireless Transmission Range	Approx. 150 meters (500 ft) if direct and unobstructed			
External Alarm Terminal (*6)	Output Terminal: Open Drain Output (Voltage when OFF: DC less than 30V / Current when ON: less than 0.1 A / Resistance when ON: about 15 Ω)			
Power	AC Adaptor AD-06A1 or AD-06C1, AA Alkaline Battery x 4			
Battery Life (*7)	Approx. 2 days (batteries only without AC adaptor)			
Dimensions	H 96 mm x W 66 mm x D 46 mm (excluding protrusions and sensor) Antenna Length: 60 mm			
Weight	Approx. 125 g (including battery, excluding sensor)			
Operating Environment	Temperature: 0 to 45 °C Humidity: 90 %RH or less (no condensation)			
Accessories	Temperature / Humidity Sensor THA-3001		Temperature / Humidity Sensor SHA-3151	
	AA Alkaline Battery LR6 x 4, AC Adaptor AD-06A1 or AD-06C1, USB Mini-B Cable US-15C, Manual (Warranty Included)			
Compatible Base Units	RTR-500, RTR-500NW/500AW, RTR-500DC, RTR-500MBS-A			

*1: Stated value is the measurement accuracy of the CO2 sensor when Auto Calibration is operating properly. A change in atmospheric pressure directly influences the reading of CO2, which can cause measurement errors; a decrease in pressure by 10hPa results in a relative decrease in CO2 by 1.6%. In such a case, we recommend carrying out the "Atmospheric Pressure Correction" function found in the software supplied with the Base Unit.

*2: Make sure to use the data logger within the operating environment as listed in the specifications.

*3: When continually used in environments with temperatures above 60°C, accuracy of humidity measurements will decrease over time. Also, humidity cannot be measured at temperatures below -20°C.

*4: Only "Endless" is available when using RTR-500W for Windows or RTR-500MBS for Windows.

*5: For communication with the Data Collector RTR-500DC (Note: Optional serial communication cable TR-6C10 is required.)

*6: In order to use the external alarm terminal, please prepare a compatible connector: JST PAP-04V-S.

*7: Battery life varies depending upon the ambient temperature in which it is used, the recording interval, the frequency of communication, and the battery performance. All estimates are based on operations carried out with a new battery and are in no way a guarantee of actual battery life.

The specifications listed above are subject to change without notice.

RTR-500 Series - Specifications

Base Unit		
	RTR-500MBS-A	RTR-500NW / RTR-500AW
Compatible Devices	Remote Units: RTR-501 / 502 / 503 / 507S / 574 / 576 / 505-TC / 505-Pt / 505-V / 505-mA / 505-P (Including L Type and S Type) Repeater: RTR-500	Remote Units: RTR-501 / 502 / 503 / 507S / 574 / 576 / 505-TC / 505-Pt / 505-V / 505-mA / 505-P (Including L Type and S Type) Repeater: RTR-500
Maximum Number of Registrations	Remote Units: 20 units (*1) Repeaters: 5 units x 4 groups	Remote Units: 100 units (*1) Repeaters: 10 units x 10 groups
Communication Interfaces	<Mobile Data Communication> US: WCDMA/HSDPA: 850 / 1900 MHz GSM/GPRS: 850 / 900 / 1800 / 1900 MHz EU: WCDMA/HSDPA: 900 / 2100 MHz GSM/GPRS: 850 / 900 / 1800 / 1900 MHz <Between Base Unit(s) - (Repeaters) - Remote Unit(s)> - Wireless Communication (short range radio communication) US: FCC Part15 Section247 / IC RSS-210 (Frequency Range: 902 to 928MHz, RF Power: 7 mW) EU: ETSI EN 300 220 (Frequency Range: 869.7 to 870MHz, RF Power: 5 mW) - Optical Communication (proprietary protocol) (With compatible Remote Units except RTR-574 and RTR-576) <Between Base Unit - PC> - USB Communication (For Setup)	<Between Base Unit(s) - (Repeaters) - Remote Unit(s)> - Wireless Communication (short range radio communication) US: FCC Part15 Section247 / IC RSS-210 (Frequency Range: 902 to 928 MHz, RF Power: 7 mW) EU: ETSI EN 300 220 (Frequency Range: 869.7 to 870 MHz, RF Power: 5 mW) - Optical Communication (proprietary protocol) (With compatible Remote Units except RTR-574 and RTR-576) <Between Base Unit - PC> - RTR-500NW: Wired LAN RJ45 Connector 100 Base-TX / 10 Base-T AutoMDI / MDI-X - RTR-500AW: Wireless LAN Internal wireless LAN antenna, IEEE 802.11b / g WEP (64bit/128bit) / WPA-PSK(TKIP) / WPA2-PSK(AES) - USB Communication (For Setup)
Wireless Transmission Range	Approx. 150 meters (500 ft) if direct and unobstructed	Approx. 150 meters (500 ft) if direct and unobstructed
External Alarm Input/Output Terminal (*2)	<Input Terminal: Contact Input> Internal Pull-up: 3 V 100 kΩ Maximum Input Voltage: 30V <Output Terminal: Photo Mos Relay Output> Voltage when OFF: AC / DC 50V or less Current when ON: 0.1 A or less Resistance when ON: 35Ω	<Input Terminal> Internal Pull-up: 3 V 100 kΩ Maximum Input Voltage: 30 V < Output Terminal > Voltage when OFF: AC / DC 50 V or less Current when ON: 0.1 A or less Resistance when ON: 35 Ω
Communications Protocol	SMTP (POP before SMTP, SMTP-AUTH <LOGIN>), SMTPS (SMTP over SSL), FTP, SMS (*3)	SMTP (POP before SMTP, SMTP-AUTH <LOGIN>), FTP, SNTP, DHCP, DNS
Power	AA Alkaline Battery (LR6) x 4 AC Adaptor (AD-05A3 or AD-05C1) (5V, 2A) External Power Supply (DC 10-24V)	AC Adaptor (AD-06A1 or AD-06C1)
Battery Life (*4)	Expected battery life with only AA alkaline batteries: Approx. 2 days under the following conditions (only one Remote Unit and no Repeaters, warning monitoring ON, downloading data once a day, sending current readings at a 10 minute interval)	-
Dimensions	H 96 mm x W 66 mm x D 39 mm (excluding antenna) Antenna Length (Cellular / Local): 109 mm	H 83 mm x W 102 mm x D 28 mm (excluding antenna) Antenna Length: 87.3 mm
Weight	Approx. 130 g	Approx. 120 g
Operating Environment	Temperature: 10 to 55 °C (-10 to 55 °C with external power connected) Humidity: 90 %RH or less (no condensation)	Temperature: -10 to 60 °C Humidity: 90 %RH or less (no condensation)
Accessories	AA Alkaline Battery (LR6) x 4, Antenna x 2 (Cellular/Local), USB Communication Cable (US-15C), External Power Cable (BC-0302), Software (CD-ROM), Introductory Manual Set (Warranty Included)	Antenna, USB Communication Cable (US-15C), LAN Cable (LN-20W, only for RTR-500NW), AC Adaptor (AD-06A1 or AD-06C1), Software (CD-ROM), Introductory Manual Set (Warranty Included)
GPS Interface (*5)	Connector: SMA Male Plug Power Supply: 2.5 to 2.7V	-
SIM Card (*3) (*6)	Standard Size SIM Card (WCDMA or GSM)	-
Software Compatible OS (*7)	Microsoft Windows 8 32 / 64 bit (*8) Microsoft Windows 7 32 / 64 bit Microsoft Windows Vista 32 bit (SP1 or later)	Microsoft Windows 8 32 / 64 bit (*8) Microsoft Windows 7 32 / 64 bit Microsoft Windows Vista 32 bit (SP1 or later)
Display Languages (*9)	English	RTR-500W for Windows (US) English, Spanish, Portuguese RTR-500W for Windows (EU) English, Spanish, French, German, Italian

*1: For RTR-574 and RTR-576, registration of one unit will be counted as two units.

*2: In order to use the external alarm terminal, please prepare a compatible connector: JST PAP-04V-S.

*3: SMS is required for some functions of the RTR-500MBS-A. If SMS is necessary, make sure that the contract you have with your carrier includes this service.

*4: Battery life varies depending upon the number of warning reports sent, the ambient temperature in which it is used, the frequency of communication, and the battery performance. All estimates are based on operations carried out with a new battery and are in no way a guarantee of actual battery life.

*5: In order to use the GPS function (to attach geographical positioning info to current readings data), please purchase a compatible GPS antenna.

*6: Please prepare a contracted SIM card separately.

*7: For installation, it is necessary to have Administrator (Computer Administrator) rights.

*8: If you are using Windows 8, please note that our software is designed to be used in "Desktop" mode only.

*9: We recommend using an operating system in the same language as the display language. Operation in different languages is not guaranteed.

The specifications listed above are subject to change without notice.

Base Unit / Repeater		
	RTR-500DC	RTR-500
Compatible Devices	Remote Units: RTR-501 / 502 / 503 / 507S / 574 / 576 / 505-TC / 505-Pt / 505-V / 505-mA / 505-P (Including L Type and S Type) Repeater: RTR-500	Remote Units: RTR-501 / 502 / 503 / 507S / 574 / 576 / 505-TC / 505-Pt / 505-V / 505-mA / 505-P (Including L Type and S Type) Repeater: RTR-500
Maximum Number of Registrations	Remote Units: 32 units x 7 groups (*1) Repeaters: 15 units x 7 groups	Remote Units: 32 units x 20 groups (*2) Repeaters: 30 units x 20 groups
Storage Capacity	When downloading from units filled to logging capacity: - 15 units of RTR-501 / 502 / 503 / 505 / 507S - 7 units of RTR-574 - 10 units of RTR-576 When downloading from units of any type containing small amounts of data, it can store and manage up to 250 download sessions.	-
Communication Interfaces	<Between Base Unit(s) - (Repeaters) - Remote Unit(s)> - Wireless Communication (short range radio communication) US: FCC Part15 Section247 / IC RSS-210 (Frequency Range: 902 to 928 MHz, RF Power: 7 mW) EU: ETSI EN 300 220 (Frequency Range: 869.7 to 870 MHz, RF Power: 5 mW) - Optical Communication (proprietary protocol) (With compatible Remote Units except RTR-574 and RTR-576) - Serial Communication (RS-232C) (*3) (With RTR-574 and RTR-576) <Between Base Unit - PC> - USB Communication - Serial Communication (RS-232C) (*4)	<Between Base Unit(s) - (Repeaters) - Remote Unit(s)> - Wireless Communication (short range radio communication) FCC Part15 Section247 / IC RSS-210 (Frequency Range: 902 to 928 MHz, RF Power: 7 mW) ETSI EN 300 220 (Frequency Range: 869.7 to 870MHz, RF Power: 5 mW) - Optical Communication (proprietary protocol) (With compatible Remote Units except RTR-574 and RTR-576) <Between Base Unit - PC> - USB Communication - Serial Communication (RS-232C) (*4)
Wireless Transmission Range	Approx. 150 meters (500 ft) if direct and unobstructed	Approx. 150 meters (500 ft) if direct and unobstructed
Communications Protocol	-	SMTP (POP before SMTP, SMTP-AUTH <LOGIN / PLAIN / CRAM-MD5>, SMTP over SSL/TLS, STARTTLS), FTP (*5)
Power	AAA Alkaline Battery (LR03) x 2 - AAA Ni-MH batteries, AC adaptor (AD-06A1 or AD-06C1), or USB bus power may also be used.	USB Bus Power, AA Alkaline Battery x 2, AC Adaptor (AD-06A1 or AD-06C1) (*6)
Battery Life (*7)	Expected battery life with 2 AAA alkaline batteries: - Monitoring Current Readings and Remote Unit Status: 96 hours of continuous use (For communication without Repeaters at 60 second intervals) - Monitoring Radio Waves: 32 hours of continuous use - Downloading Data via Wireless Communication: 730 consecutive sessions (When downloading RTR-501 at full logging capacity, without Repeaters, with LCD backlight Off)	As a Repeater: Approx. 6 months (When downloading full data once a day with one Repeater)
Dimensions	H 125 mm x W 58 mm x D 26.3 mm (excluding antenna) Antenna Length: 109 mm	H 96 mm x W 65 mm x D 25 mm (excluding antenna) Antenna Length: 109 mm
Weight	Approx. 105 g	Approx. 70 g
Operating Environment	Temperature: 0 to 50 °C Humidity: 90 %RH or less (no condensation)	Temperature: -10 to 60 °C (-30 to 60 °C with external power connected) Humidity: 90 %RH or less (no condensation)
Accessories	AAA Alkaline Battery (LR03) x 2, USB Communication Cable (US-15C), Software (CD-ROM), Introductory Manual Set (Warranty Included)	Antenna, USB Communication Cable (US-15C), Software (CD-ROM), Memo Sticker, Introductory Manual Set (Warranty Included)
Software Compatible OS (*8)	Microsoft Windows 8 32 / 64 bit (*9) Microsoft Windows 7 32 / 64 bit Microsoft Windows Vista 32 bit (SP1 or later)	Microsoft Windows 8 32 / 64 bit (*9) Microsoft Windows 7 32 / 64 bit Microsoft Windows Vista 32 bit (SP1 or later)
Display Languages (*10)	RTR-500DC for Windows (US) English, Spanish, Portuguese RTR-500DC for Windows (EU) English, Spanish, French, German, Italian	RTR-500 for Windows (US) English, Spanish, Portuguese RTR-500 for Windows (EU) English, Spanish, French, German, Italian

*1: For RTR-505, RTR-574, and RTR-576, registration of one unit will be counted as two units.

*2: For RTR-574 and RTR-576, registration of one unit will be counted as two units.

*3: Optional communication cable TR-6C10 is required for serial communication with RTR-574 and RTR-576.

*4: Customers wishing to write their own software, please contact your local distributor for the serial communications protocol specifications. (Note: Optional serial communication cable TR-07C is also required.)

*5: For RTR-500, the protocol is implemented in the software.

*6: When using a USB connection, the RTR-500 requires neither batteries nor AC adaptor. Please prepare two AA batteries or an AC adaptor when using the RTR-500 as a Repeater.

*7: Battery life varies depending upon the ambient temperature in which it is used, the frequency of communication, and the battery performance. All estimates are based on operations carried out with a new battery and are in no way a guarantee of actual battery life.

*8: For installation, it is necessary to have Administrator (Computer Administrator) rights.

*9: If you are using Windows 8, please note that our software is designed to be used in "Desktop" mode only.

*10: We recommend using an operating system in the same language as the display language. Operation in different languages is not guaranteed.

The specifications listed above are subject to change without notice.

High Performance Analysis Tool: T&D Graph

Our new easy-to-use high performance software "T&D Graph" gives you all the power you need for effective management and analysis of recorded data. It can also be used in conjunction with **T&D WebStorage Service**.

Open Only the Data you Need

It is possible to specify search conditions to find and open only the data you want from all recorded data stored in a local folder or in the **T&D WebStorage Service**. The merging of multiple sets of data is also possible.

Open data directly from T&D WebStorage Service

Open only data that matches search conditions

Data is automatically merged and opened.

Analyze

Use the filtering feature to get only the data you want to view and work with. Pre-designed filtering templates are provided; or create your own.

Use the text and figure editing feature to create memos and comments within graphs.

Save / Output

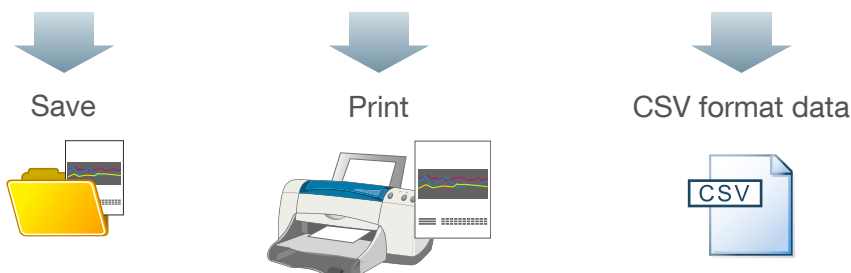

www.tandd.com

DISTRAME S.A. - Parc du Grand Troyes - Quartier Europe Centrale - 40, rue de Vienne - 10300 SAINTE-SAVINE
Tél. : +33 (0)3 25 71 25 83 - Fax : +33 (0)3 25 71 28 98 - E-mail : infos@distrame.fr - Site internet : www.distrame.fr

- Colors in the photos in this catalog may be different from real product colors. The specifications and designs of the products in this catalog are true as of Dec 2017.
- Specifications are subject to change without notice. Microsoft® and Windows® are registered trademarks of Microsoft Corporation USA and other countries. GSM is a trademark of GSM MOU Association. All registered trademarks, company names, product names and logos mentioned herein are the property of T&D Corporation or of their respective owners.

 **T&D Corporation**