



## Single Device Solution for High Speed Testing and Frequency Sweeping

With this new IM3570 Impedance Analyzer, an LCR meter and an impedance analyzer capable of measurement frequencies of 4 Hz to 5 MHz and test signal levels of 5 mV to 5 V have been combined into one measuring instrument. Advanced capabilities include LCR measurement with AC signals, resistance measurement with direct current (Rdc), and sweep measurement which continuously changes the measurement frequency and measurement level.

The IM3570 facilitates high-speed continuous measurement under different measurement conditions and measurement modes, so inspection lines which up to now have required multiple measuring instruments can be equipped with just one device.

# LCR measurement, Rdc measurement, and Sweep measurement Continuous Measurement and High-speed Testing Achieved with One Instrument



## Measurements recommended with IMPEDANCE ANALYZER IM3570

### 1. Testing the resonance characteristics of piezoelectric elements

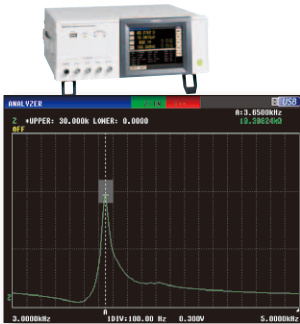

Frequency sweep measurement  
Z peak comparator screen



LCR mode  
Cs display screen (1 kHz measurement)

Reduce Equipment Costs with  
Just 1 Device!

Frequency sweep measurement can be used to measure the resonance frequency and its impedance, and then the peak comparator function can be used to make a pass/fail judgment on the resonance state.

In LCR mode, you can test capacitance by performing C measurement between 1 kHz and 120 Hz.



Continuous measurement screen



High Speed and  
High Accuracy

Frequency sweep measurement (impedance analyzer) and C measurement can be performed continuously with one instrument.

### Advantage #1 -- Measurement time shortened

The measurement time has been shortened from previous models, achieving maximum speeds of 1.5ms\* (1 kHz) and 0.5ms\* (100kHz) in LCR mode. This is a significant increase in speed compared with previous Hioki products (3522-50 and 3532-50 with basic speed of 5ms). Faster speed contributes to an increase in test quantities. Furthermore, sweep measurement, which requires multiple points to be measured, realizes the quick speed of 0.3ms per point.

\* When the display is off (time increases by 0.3 ms when the display is on).

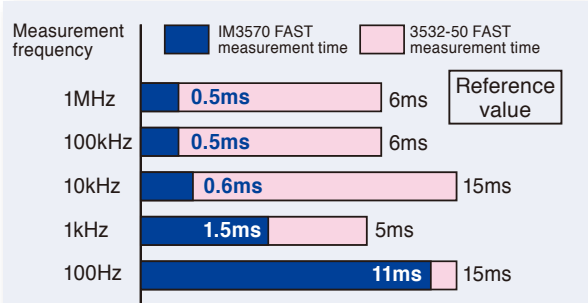

Comparison of measurement time of IM3570 and 3532-50

# Perfect Impedance Analyzer for Production Lines

## 2. C-D and low ESR measurement of functional polymer capacitors

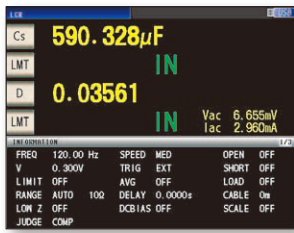

LCR mode  
Cs and D display screen (120 Hz measurement)

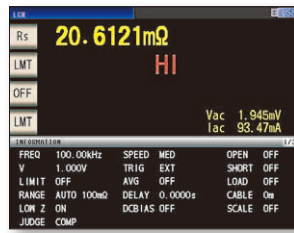

LCR mode  
Rs display screen (100 kHz measurement)



Continuous measurement screen

C-D (120 Hz) and low ESR (100 kHz) measurement can be performed for functional polymer capacitors.

Make continuous tests for different measurement items under different measurement conditions (frequency, level, and mode).

### Advantage #2 -- Low-impedance measurement accuracy improved

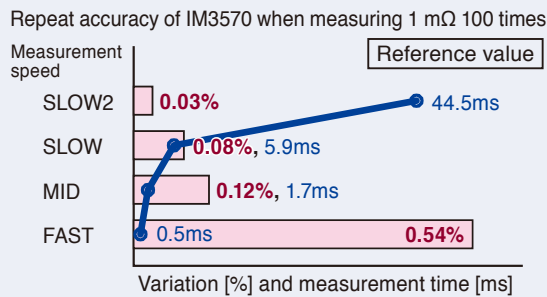

A one-digit improvement in repeat accuracy during low-impedance measurement has been achieved compared with previous Hioki products. For example, when the condition is 1 mΩ (1V, 100 kHz) and the measurement speed is MED, stable measurement with a repeat accuracy (variation)\* of 0.12% is possible, making this instrument suitable for 100 kHz ESR measurement.

\* Repeat accuracy (variation) is calculated based on the difference between the maximum and minimum values.

## 3. Rdc and L-Q measurement of inductors (coils and transformers)

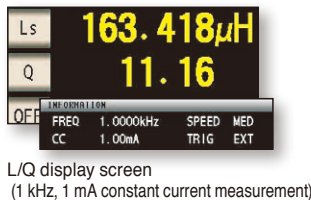

L/Q display screen  
(1 kHz, 1 mA constant current measurement)

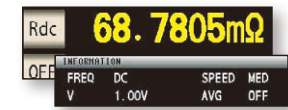

Rdc display screen  
(DC measurement)

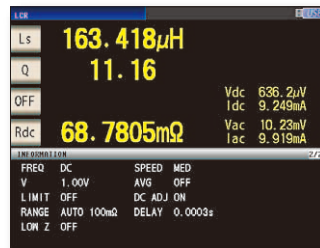

L/Q/Rdc continuous measurement screen  
L/Q (1 kHz, 1 mA constant current measurement) and Rdc (DC measurement) display screen

The instrument can continuously measure L-Q (1 kHz, 1mA constant current) and Rdc, and display the numerical values on the same screen. Current dependent elements such as coils incorporating cores for which the inductance value varies depending on the applied current can be measured with a constant current (CC). Since there is a one-digit improvement in repeat accuracy during low impedance measurement compared with previous products, stable measurement of Rdc can be expected.

### Advantage #3

By improving the measurement accuracy of  $\theta$  compared with previous Hioki products, measurement with an absolute accuracy and repeat accuracy of one-digit better than before can be performed for high Q and Rs values for which  $\theta$  is in the vicinity of 90°.

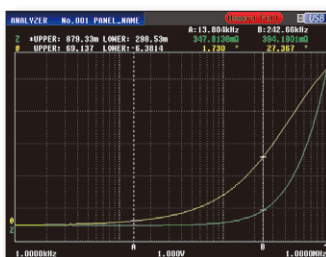

Frequency sweep measurement  
Z-θ measurement screen

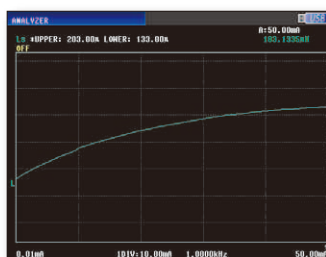

CC value sweep measurement  
Ls measurement screen

The measurement frequency of a coil differs depending on the application. The wide measurement range of 4 Hz to 5 MHz facilitates the measurement of various coils.

Constant current sweep measurement enables a current characteristic graph to be displayed for current dependent elements.

# Test Efficiency Improved by High-speed and High-accuracy Measurements

## Features of IM3570

### Low-capacitance (high-impedance) measurement with improved stability

There is a one-digit improvement in repeat accuracy during low-capacitance (high-impedance) measurement compared with previous Hioki products. For example, when the condition is 1 pF (1 MHz, 1 V) and the measurement speed is SLOW2, stable measurement with a repeat accuracy (variation)\* of 0.01% is possible.

At the same time, phase repeat accuracy is also improved, which in turn has improved the stability of D measurement during low-capacitance (high-impedance) measurement.

\* Repeat accuracy (variation) is calculated based on the difference between the maximum and minimum values.

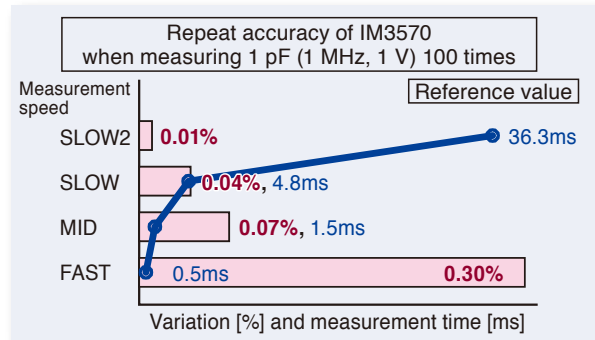

### Wide setting range for measurement frequency

IM3570 allows DC or a frequency band within the range of 4 Hz to 5 MHz to be set with five-digit resolution (testing at less than 1 KHz has a 0.01 Hz resolution). This enables the measurement of resonance frequency and measurement and evaluation in a state close to that of actual operating conditions.

### 15 parameters measured

The following parameters can be measured and selected parameters can be captured by a computer: Z, Y,  $\theta$ , Rs (ESR), Rp, Rdc (DC resistance), X, G, B, Ls, Lp, Cs, Cp, D (tan $\delta$ ), and Q.

### Incorporates contact check function (open-circuit check)

The contact check function for four-terminal measurement (only for low impedance high accuracy mode) and two-terminal measurement prevents measurement in a state in which a measurement electrode is not in contact with the measurement object.

### Comparator and BIN functions

In LCR mode, the instrument allows for Hi, IN, and Lo judgments of two types from the measurement items on one screen. For the judgment method, % setting and  $\Delta\%$  setting are available in addition to absolute value setting. If continuous measurement is used, judgments which span over multiple measurement conditions and measurement items are possible. The BIN function can be used to classify two types of measurement items on one screen into 10 categories and out of range. In analyzer mode, the peak comparator for judging whether resonance points pass or fail can be used.

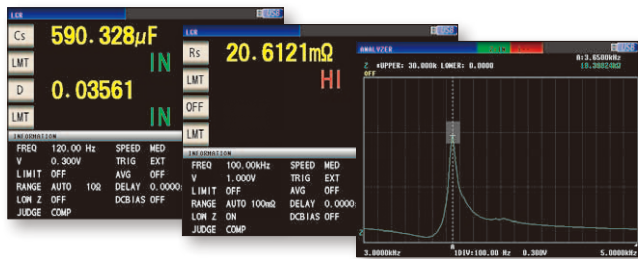

### Segment setting

Up to 20 segments with a total of up to 801 points can be set for the sweep range. This is effective for evaluating multiple frequency ranges in detail.

### Memory function

Up to 32,000 measurement results can be stored in the memory of the instrument. The saved measurement results can be copied to a USB flash drive, and can also be acquired using a communication command.

### Wide setting range for measurement voltage and current

In addition to normal open-loop signal generation, this instrument enables measurement considering voltage/current dependence in constant voltage and constant current modes. The signal levels can be set over wide ranges, from 5 mV to 5 V, and from 10  $\mu$ A to 50 mA (up to 1 MHz). (The setting range of measurement signal levels differs depending on the frequency and measurement mode.)

### DC bias can be generated internally

Up to a 2.5 V DC bias can be applied and then measurement performed with just the unit. This is reassuring when measuring polar capacitors such as a tantalum capacitor. The charge impedance is 100  $\Omega$ . (The DC bias unit required with 3522-50 and 3532-50 is not needed for IM3570 within the bias voltage range of 0 to +2.5V. If a larger bias voltage is required, an external option, which is scheduled to be released in the future, is required.)

### High resolution with up to 7-digit display

High-resolution measurement with full 7-digit display is possible. The number of display digits can be set from 3 to 7.

### Four-terminal probe allows for use at DC to 8 MHz

The L2000 4-terminal probe (option) employs a 4-terminal structure to facilitate 50  $\Omega$  characteristic impedance and improved measurement accuracy, and is well suited to the IM3570.

### Measurement cable extendable to up to 4 meters

Accuracy is guaranteed at the measurement cable lengths of 0, 1, 2, and 4 meters. This makes wiring automated machinery simple. (The frequency range for which accuracy is guaranteed differs depending on the cable length. The probe needs to be provided by the customer.)

### Longer stability

Measurement accuracy is guaranteed for one year. Previous models required calibration every 6 months, but with this model the calibration interval has been extended to one year.

### Interval measurement

In order to, for example, confirm the temporal changes of an element from the response of a sensor, parameter time variations can be measured for up to 801 points at a specified interval (100  $\mu$ s to 10,000s), and then the data can be displayed in a graph or list.

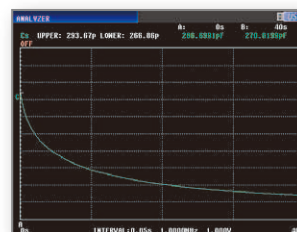

Interval setting screen

Link with computer via USB, LAN, RS-232C, or GP-IB

# Effective for Acquisition and Analysis of Measurement Data

## EQUIVALENT CIRCUIT ANALYSIS FIRMWARE IM9000 (option)

- Five equivalent circuit analysis (Auto/Fixed) patterns
- Acceptance/rejection decision for equivalent circuit elements
- Analysis results simulation
- Cole-Cole plot and admittance circle display

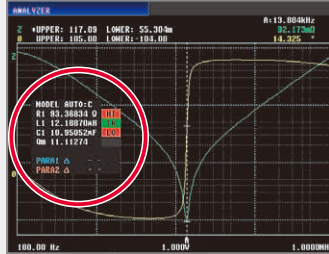

Acceptance/rejection decision screen for equivalent circuit elements



Analysis results simulation screen

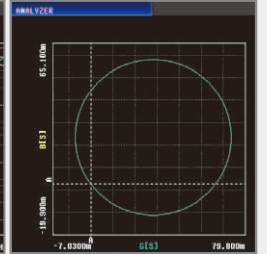

Admittance circle display screen

### Equivalent Circuit Model and Measurement Items

#### Three-element model

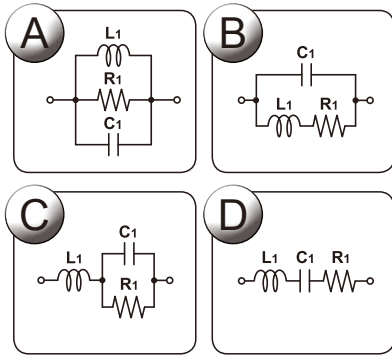

#### Measurement items

- L1 (Inductance)
- C1 (Capacitance)
- R1 (Resistance)
- Qm (Resonance sharpness)
- fr (Resonance frequency) / fa (Anti-resonance frequency)

#### Four-element model

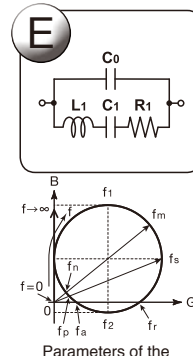

#### Measurement items

- L1 (Inductance)
- C1 (Capacitance)
- R1 (Resistance)
- C0 (Parallel capacitance)
- Qm (Resonance sharpness or mechanical quality coefficient)
- fr (Resonance frequency)
- fa (Anti-resonance frequency)
- fs (Series resonance frequency)
- fp (Parallel resonance frequency)
- fm (Maximum admittance frequency)
- fn (Minimum admittance frequency)
- f1 (Maximum susceptance frequency)
- f2 (Minimum susceptance frequency)

## Saving and reading data via front-loading USB port

Measurement results and settings can be saved to a commercially available USB flash drive connected to the front panel.

(The USB port on the front panel is specifically for a USB flash drive. Batch save all measurement results to a USB flash drive after saving them to the internal memory of IM3570. Some USB flash drives may not be able to be used due to incompatibility issues.)

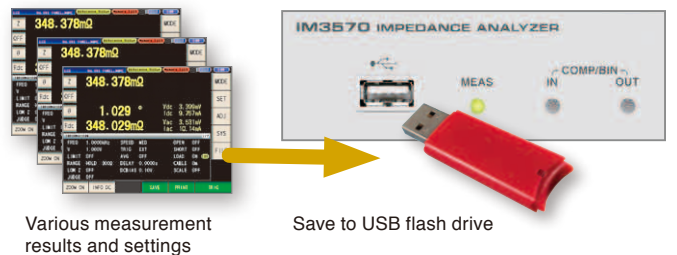

Various measurement results and settings

Save to USB flash drive

## External control from PC or PLC via USB, LAN, GP-IB, or RS-232C connection

The rear panel is standard equipped with RS-232C, GP-IB, USB and LAN ports. (The USB port on the rear panel is specifically for connecting a PC.)

Various functions of IM3570 can be controlled from a PLC or PC, and measurement results can be acquired. (Excluding turning the power on/off and configuring some interface settings.)

Use of an interface suitable for automated machinery enables you to build the optimal measurement system.

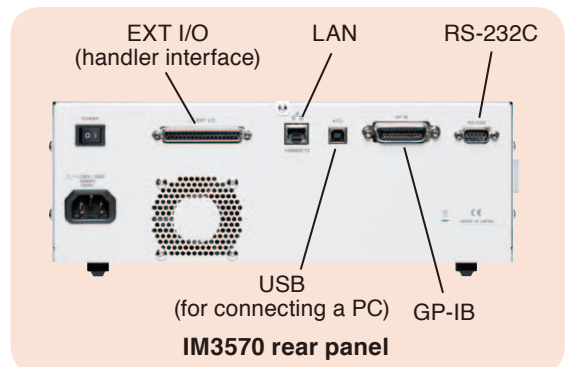

IM3570 rear panel

## EXT I/O

### Handler (EXT I/O) interface

The handler (EXT I/O) interface enables output of an end of measurement signal and measurement result signal, and input of signals such as a measurement trigger signal to control the measuring instrument. Each of the signal lines is isolated from the control circuit, and the structure is designed to protect against noise.

#### Example of representative EXT I/O timing

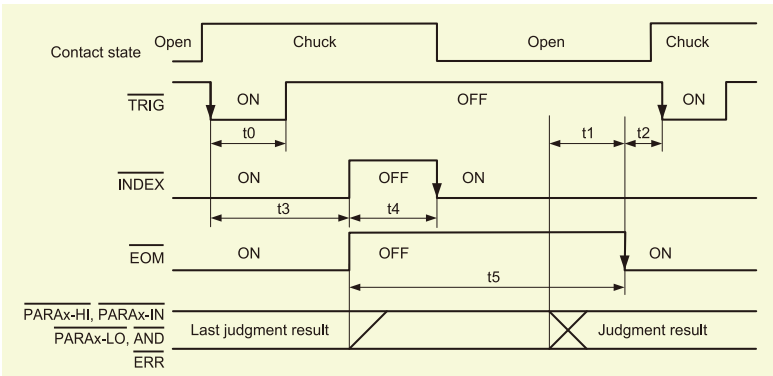

t0: Minimum time for trigger signal: 0.3 ms or longer \*1

t1: Delay setting time from comparator and BIN judgment results to  $\overline{\text{EOM}}$  (LOW): 0.04 ms or longer \*1

t2: Minimum time from end of measurement to next trigger: 0.4 ms \*1

t3: Time from trigger to response by circuit: 0.7 ms \*1

t4: Minimum chuck time for which chuck can be switched with  $\overline{\text{INDEX}}$  (LOW): 0.3 ms \*1

t5: Measurement time: 0.5 ms \*1

\*1: When the measurement speed is FAST and the range is HOLD.

#### Connectors

Connectors to use (unit side) : 37-pin D-SUB female connector with #4-40 inch screws

Compliant connectors : DC-37P-ULR (solder type) and DCSP-JB37PR (insulation-displacement type)  
For information on where to obtain connectors, consult your nearest HIOKI distributor.

## IM3570 specifications

(Accuracy guaranteed for 1 year, Post-adjustment accuracy guaranteed for 1 year)

<b>Measurement modes</b>	LCR mode: Measurement with single condition Analyzer mode: Sweeps with measurement frequency and measurement level (Measurement points: 1 to 801, Measurement method: normal sweep or segment sweep, Display: List display or graph display) Continuous measurement mode: Measures under saved conditions continuously (maximum of 32 sets)
<b>Measurement parameters</b>	Z Impedance Y Admittance $\theta$ Phase angle Rs(ESR) Series-equivalent resistance = ESR Rp Parallel-equivalent resistance Rdc DC resistance X Reactance G Conductance B Susceptance Cs Series-equivalent static capacitance Cp Parallel-equivalent static capacitance Ls Series-equivalent inductance Lp Parallel-equivalent inductance D(tan $\delta$ ) Loss coefficient = $\tan \delta$ ( $\delta = \text{delta}$ ) Q Q factor ( $Q = 1/D$ )
<b>Measurement range</b>	100 m $\Omega$ to 100 M $\Omega$ , 12 ranges (All parameters are determined according to Z)
<b>Display range</b>	Z, Y, Rs, Rp, Rdc, X, G, B, Ls, Lp, Cs, Cp : $\pm(0.000000 \text{ [unit]} \text{ to } 9.999999\text{G [unit]})$ Absolute value display for Z and Y only $\theta : \pm(0.000^\circ \text{ to } 180.000^\circ)$ D : $\pm(0.000000 \text{ to } 9.999999)$ Q : $\pm(0.00 \text{ to } 99999.99)$ $\Delta \% : \pm(0.0000\% \text{ to } 999.9999\%)$
<b>Basic accuracy</b>	Z : $\pm 0.08\% \text{rdg.}$ $\theta : \pm 0.05^\circ$
<b>Measurement frequency</b>	4Hz to 5MHz (5 digits setting resolution, minimum resolution 10 mHz)
<b>Measurement signal level</b>	Normal mode: V mode/CV mode: 5 mV to 5 Vrms (up to 1 MHz), 10 mV to 1 Vrms (1 MHz to 5 MHz), 1 mVrms steps CC mode: 10 $\mu\text{A}$ to 50 mArms (up to 1 MHz), 10 $\mu\text{A}$ to 10 mArms (1 MHz to 5 MHz), 10 $\mu\text{Arms}$ steps Low impedance high accuracy mode: V mode/CV mode: 5 mV to 1 Vrms (up to 100 kHz), 1 mVrms steps CC mode: 10 $\mu\text{A}$ to 100 mArms (100 m $\Omega$ and 1 $\Omega$ ranges of up to 100 kHz), 10 $\mu\text{Arms}$ steps

<b>Output impedance</b>	Normal mode: 100 $\Omega$ Low impedance high accuracy mode: 10 $\Omega$
<b>Display</b>	5.7-inch color TFT, display can be set to ON/OFF
<b>No. of display digits setting</b>	The number of display digits can be set from 3 to 7 (initial value: 6 digits)
<b>Measurement time</b>	0.5 ms (100 kHz, FAST, display OFF, representative value)
<b>Measurement speed</b>	FAST/MED/SLOW/SLOW2
<b>DC bias measurement</b>	Normal mode: 0 VDC to 2.50 VDC (10 mV steps) Low impedance high accuracy mode: 0 VDC to 1.00 VDC (10 mV steps)
<b>DC resistance measurement</b>	Normal mode Measurement signal level: 100 mVDC to 2.5 VDC (10 mV steps) Low impedance high accuracy mode Measurement signal level: 100 mVDC to 1.00 VDC (10 mV steps)
<b>Comparator</b>	LCR mode: Hi/IN/Lo for first and third items Analyzer mode: Area judgment (Hi/IN/Lo for each point) Peak judgment (Hi/IN/Lo for local maximum and local minimum frequency and absolute values)
<b>BIN measurement</b>	10 classifications and out of range for 2 items
<b>Compensation</b>	Open/short/load/cable length of 0 and 1 m/correlation compensation
<b>Residual charge protection function</b>	$V = \sqrt{10/C}$ (C: Capacitance [F] of test sample, V = max. 400 V)
<b>Trigger synchronous output function</b>	Applies a measurement signal during analog measurement only
<b>Averaging</b>	1 to 256
<b>Interval measurement</b>	100 $\mu\text{s}$ to 10,000 s, max. 801 points
<b>Panel loading/saving</b>	LCR mode: 30; Analyzer mode: 2; Compensation value: 128
<b>Memory function</b>	Stores 32,000 data items to the memory of the instrument
<b>Interfaces</b>	EXT I/O (handler), RS-232C, GP-IB, USB (Hi-Speed/Full-Speed), USB flash drive, LAN (10BASE-T/100BASE-TX)
<b>Operating temperature and humidity ranges</b>	0°C to 40°C, 80% RH or less, no condensation
<b>Storage temperature and humidity ranges</b>	-10°C to 50°C, 80% RH or less, no condensation
<b>Power supply</b>	90 to 264 V AC, 50/60 Hz, 150 VA max.
<b>Dimensions and weight</b>	Approx. 330 (W) x 119 (H) x 307 (D), approx. 5.8 kg
<b>Accessory</b>	Power Cord x 1, Instruction Manual x 1, Communication Instruction Manual (CD) x 1

# IM3570 measurement accuracy

## Conditions

Temperature and humidity ranges: 23°C ± 5°C, 80% RH or less (no condensation), at least 60 minutes after power turned on, after performing open and short compensation

**Basic accuracy (Z, θ) calculation expression**

In the 1 kΩ range and above and 300 Ω range and below, the calculation expression of basic accuracy differs as shown below. For details, refer to the following calculation examples.

**Top A: Basic accuracy of Z (± % rdg.)**  
B is the coefficient for the impedance of the sample

**1 kΩ range and above:**  
Accuracy =  $A + B \times \left| \frac{10 \times Z_x}{\text{Range}} - 1 \right|$

**Bottom A: Basic accuracy of θ (± % deg.)**  
B is the coefficient for the impedance of the sample

**300 Ω range and below:**  
Accuracy =  $A + B \times \left| \frac{\text{Range}}{Z_x} - 1 \right|$

Z<sub>x</sub> is the actual impedance measurement value (Z) of the sample.

A is the accuracy of R when DC (± % rdg.)  
B is the coefficient for the resistance of the sample

The measurement accuracy is calculated based on the following equation.  
Measurement accuracy = Basic accuracy × C × D × E × F × G

- [C: Level coefficient] V: Setting value (corresponds to when V mode) [V]  
0.005V to 0.999V :  $1 + \frac{0.1}{V}$  (For measurements other than Rdc, at 30kΩ range or below)  
 $1 + \frac{0.3}{V}$  (All Rdc ranges, and 100kΩ range and above for measurements other than Rdc)
- 1V to 5V : 1
- [D: Measurement speed coefficient]  
FAST : 8, MED : 4, SLOW : 2, SLOW2 : 1
- [E: Measurement cable length coefficient] fm: Measurement frequency [kHz]  
0 m : 1 (DC to 5MHz), 1 m : 1.5 (DC to 5MHz),  
2 m :  $2 \times \left(1 + \frac{fm}{100}\right)$  (DC to 100kHz), 4 m :  $4 \times \left(1 + \frac{fm}{100}\right)$  (DC to 10kHz)
- [F: DC bias coefficient] V<sub>AC</sub>: AC signal voltage setting value [V]  
DC bias setting OFF : 1  
DC bias setting ON :  $2 \times \left(1 + \frac{0.1}{V_{AC}}\right)$ ,  $4 \times \left(1 + \frac{0.1}{V_{AC}}\right)$  (At 10Ω range or below, minimum 100.01 kHz.)
- [G: Temperature coefficient] t: Operating temperature  
When t is 18°C to 28°C : 1, When t is 0°C to 18°C or 28°C to 40°C :  $1 + 0.1 \times |t - 23|$

## Basic accuracy

Range	Guaranteed accuracy range	DC	4 Hz to 99.9 Hz	100 Hz to 999.99 Hz	1 kHz to 10 kHz	10.01 kHz to 100 kHz	100.1 kHz to 1 MHz	1.001 MHz to 5 MHz
100MΩ	8MΩ to 200MΩ	A=4 B=6	A=6 B=5 A=5 B=3	A=3 B=2 A=2 B=2	A=3 B=2 A=2 B=2	A=8 B=4 A=3 B=2		* Set the accuracy to $\frac{(f[\text{MHz}] + 3)}{4}$ times for 1.001 MHz or above.
10MΩ	800kΩ to 100MΩ	A=0.5 B=0.3	A=0.8 B=1 A=0.8 B=0.5	A=0.5 B=0.3 A=0.4 B=0.2	A=0.5 B=0.3 A=0.4 B=0.2	A=1 B=0.7 A=1 B=0.2	A=3 B=2 A=3 B=1	
1MΩ	80kΩ to 10MΩ	A=0.2 B=0.1	A=0.4 B=0.08 A=0.3 B=0.08	A=0.3 B=0.05 A=0.2 B=0.02	A=0.3 B=0.05 A=0.2 B=0.02	A=0.3 B=0.08 A=0.3 B=0.08	A=1 B=0.5 A=1 B=0.5	* A=2 B=1 A=2 B=1
100kΩ	24kΩ to 1MΩ	A=0.1 B=0.01	A=0.3 B=0.01 A=0.3 B=0.01	A=0.2 B=0.01 A=0.1 B=0.01	A=0.15 B=0.01 A=0.1 B=0.01	A=0.25 B=0.04 A=0.2 B=0.02	A=0.4 B=0.3 A=0.3 B=0.3	* A=2 B=0.5 A=2 B=0.3
30kΩ	8kΩ to 300kΩ	A=0.1 B=0.01	A=0.3 B=0.01 A=0.3 B=0.01	A=0.2 B=0.005 A=0.1 B=0.003	A=0.12 B=0.005 A=0.08 B=0.003	A=0.25 B=0.01 A=0.15 B=0.005	A=0.4 B=0.05 A=0.3 B=0.03	* A=2 B=0.1 A=2 B=0.1
10kΩ	2.4kΩ to 100kΩ	A=0.1 B=0.01	A=0.3 B=0.01 A=0.3 B=0.01	A=0.2 B=0.01 A=0.1 B=0.005	A=0.12 B=0.005 A=0.08 B=0.002	A=0.2 B=0.02 A=0.08 B=0.02	A=0.3 B=0.03 A=0.2 B=0.05	* A=1.5 B=0.2 A=1 B=0.2
3kΩ	800Ω to 30kΩ	A=0.1 B=0.01	A=0.3 B=0.02 A=0.2 B=0.01	A=0.2 B=0.005 A=0.1 B=0.002	A=0.12 B=0.005 A=0.08 B=0.002	A=0.2 B=0.005 A=0.08 B=0.005	A=0.3 B=0.01 A=0.15 B=0.01	* A=1.5 B=0.02 A=1 B=0.03
1kΩ	240Ω to 10kΩ	A=0.1 B=0.01	A=0.3 B=0.02 A=0.2 B=0.01	A=0.2 B=0.01 A=0.1 B=0.005	A=0.1 B=0.005 A=0.08 B=0.002	A=0.2 B=0.01 A=0.08 B=0.01	A=0.3 B=0.01 A=0.15 B=0.01	* A=1.5 B=0.01 A=1 B=0.01
300Ω	8Ω to 300Ω	A=0.1 B=0.02	A=0.4 B=0.02 A=0.2 B=0.01	A=0.3 B=0.02 A=0.15 B=0.01	A=0.08 B=0.02 A=0.05 B=0.01	A=0.2 B=0.02 A=0.08 B=0.02	A=0.3 B=0.03 A=0.15 B=0.02	* A=1.5 B=0.05 A=1 B=0.05
10Ω	800mΩ to 10Ω	A=0.2 B=0.15	A=0.5 B=0.2 A=0.3 B=0.1	A=0.4 B=0.05 A=0.3 B=0.03	A=0.3 B=0.05 A=0.15 B=0.03	A=0.3 B=0.05 A=0.15 B=0.03	A=0.4 B=0.2 A=0.3 B=0.1	* A=2 B=1.5 A=2 B=1
1Ω	80mΩ to 1Ω	A=0.3 B=0.3	A=2 B=1 A=1 B=0.6	A=0.6 B=0.3 A=0.5 B=0.2	A=0.4 B=0.3 A=0.25 B=0.2	A=0.4 B=0.3 A=0.25 B=0.2	A=1 B=1 A=0.7 B=0.5	* A=3 B=3 A=3 B=2
100mΩ	1mΩ to 100mΩ	A=3 B=2	A=10 B=10 A=6 B=6	A=3 B=3 A=2 B=2	A=3 B=3 A=2 B=1.5	A=2 B=2 A=2 B=1.5	A=4 B=3 A=3 B=4	

### ● Method of determining basic accuracy

- Calculate the basic accuracy from the sample impedance, measurement range, and measurement frequency and the corresponding basic accuracy A and coefficient B from the table above.
- The calculation expression to use differs for each of the 1 kΩ range and above and 300 Ω range and below.
- For C and L, obtain basic accuracy A and coefficient B by determining the measurement range from the actual measurement value of impedance or the approximate impedance value calculated with the following expression.

$$Z_x (\Omega) \approx \omega L (H) \quad (\theta \approx 90^\circ)$$

$$\approx \frac{1}{\omega C (F)} \quad (\theta \approx -90^\circ)$$

$$\approx R (\Omega) \quad (\theta \approx 0^\circ) \quad (\omega: 2 \times \pi \times \text{Measurement frequency [Hz]})$$

### ● Calculation example

Impedance Z<sub>x</sub> of sample: 500 Ω (actual measurement value)  
Measurement conditions: When frequency 10 kHz and range 1 kΩ

Insert coefficient A = 0.1 and coefficient B = 0.005 for the Z basic accuracy from the table above into the expression.

$$Z \text{ basic accuracy} = 0.1 + 0.005 \times \left| \frac{10 \times 500}{10^3} - 1 \right| = 0.12 (\pm \% \text{rdg.})$$

Similarly, insert coefficient A = 0.08 and coefficient B = 0.002 for the θ basic accuracy, as follows:

$$\theta \text{ basic accuracy} = 0.08 + 0.002 \times \left| \frac{10 \times 500}{10^3} - 1 \right| = 0.088 (\pm \% \text{deg.})$$

## Guaranteed accuracy range (measurement signal level)

The guaranteed accuracy range differs depending on the measurement frequency, measurement signal level, and measurement range.

Range	DC	4 Hz to 99.9 Hz	100 Hz to 999.99 Hz	1 kHz to 10 kHz	10.01 kHz to 100 kHz	100.1 kHz to 1 MHz	1.001 MHz to 5 MHz	
100MΩ	1 V to 2.5 V		0.101 V to 5 V		0.501 V to 5 V			
10MΩ	0.1 V to 2.5 V		0.050 V to 5 V		0.101 V to 5 V	0.501 V to 5 V		
1MΩ					0.050 V to 5 V	0.101 V to 5 V	0.501 V to 1 V	
100kΩ						0.050 V to 5 V	0.101 V to 1 V	
30kΩ, 10kΩ, 3kΩ, 1kΩ, 300Ω, 10Ω				0.005 V to 5 V				0.050 V to 1 V
1Ω				0.005 V to 5 V <sup>*2</sup>		0.101 V to 5 V	0.501 V to 1 V	
100mΩ	0.1 V to 2.5 V <sup>*1</sup>		0.101 V to 5 V <sup>*3</sup>		0.501 V to 5 V <sup>*3</sup>			

The above voltages are the voltage setting values correspond to when in V mode.

\*1 Guaranteed accuracy of 10 mΩ or above, \*2 Guaranteed accuracy of 0.101 V to 5 V when DC bias, \*3 Guaranteed accuracy of 10 mΩ or above and 1.001 V to 5 V when DC bias



**Model : IMPEDANCE ANALYZER IM3570**

Model No. (Order Code) (Note)

**IM3570**

Accessories: Power cord x1, Instruction manual x1, PC communication instruction manual (CD-R) x1

Note: Test fixtures are not supplied with the instrument. Select optional test fixtures or probes when ordering.

**Options**

**EQUIVALENT CIRCUIT ANALYSIS FIRMWARE IM9000**

(Factory-installed option)

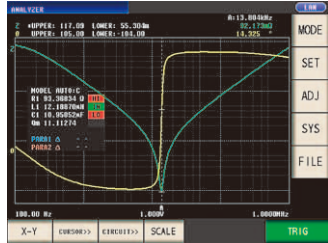

The Equivalent Circuit Analysis Firmware IM9000 is an optional function for the Impedance Analyzer IM3570. The IM9000 is not included in the standard package. If you want to use the IM9000, specify the option upon purchase.

Customers who have purchased the Impedance Analyzer IM3570 can add the Equivalent Circuit Analysis Firmware IM9000 function. Please contact your Hioki distributor.

**Test Fixtures for SMDs**



**SMD TEST FIXTURE IM9110**

Measurable range: DC to 1 MHz, For SMD with electrodes on side, Measurable sample sizes: 008004 (EIA), 0201 (JIS), Please contact Hioki for information about other sizes, Direct connection type



**SMD TEST FIXTURE IM9100**

Measurable range: DC to 8 MHz, For SMD with electrodes on bottom, Measurable sample sizes: 01005 to 0402 (EIA) 0402 to 1005 (JIS), Direct connection type



**SMD TEST FIXTURE 9677**

Direct connection type, for SMDs with electrodes on the side, DC to 120 MHz, SMD sizes: 3.5 ± 0.5 mm



**PINCHER PROBE L2001**

\*Ships standard with one set of IM9901

Cable length 730 mm (2.40 ft), DC to 8 MHz, characteristic impedance of 50 Ω, 4-terminal pair design, 2-terminal electrode, tip electrode spacing of 0.3 to approx. 6 mm (0.01 to approx. 0.24 in)

**Options for L2001**

Replaceable contact tips



**CONTACT TIPS IM9901**

Compatible chip sizes: 1608 to 5750 (JIS)



**CONTACT TIPS IM9902**

Compatible chip sizes: 0603 to 5750 (JIS)



**SMD TEST FIXTURE 9699**

Direct connection type, for SMDs with electrode on the bottom, DC to 120 MHz, SMD sizes: 1.0 to 4.0 mm wide, 1.5 mm or less high



**SMD TEST FIXTURE 9263**

Direct connection type, DC to 8 MHz, SMD sizes: 1 to 10 mm (0.04 to 0.39 in)

**Probes and Test Fixtures for Lead Components**



**FOUR-TERMINAL PROBE L2000**

Cable length 1 m (3.28 ft), DC to 8 MHz, characteristic impedance of 50 Ω, 4-terminal pair design, measurable conductor diameter: 0.3 to 5 mm (0.01 to 0.20 in)

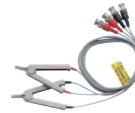

**FOUR-TERMINAL PROBE 9140-10**

Cable length 1 m (3.28 ft), DC to 200 kHz, characteristic impedance of 50 Ω, 4-terminal pair design, measurable conductor diameter: 0.3 to 5 mm (0.01 to 0.20 in)



**TEST FIXTURE 9262**

Direct connection type, DC to 8 MHz, measurable conductor diameter: 0.3 to 2 mm (0.01 to 0.08 in)

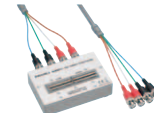

**TEST FIXTURE 9261-10**

Cable length 1 m (3.28 ft), DC to 8 MHz, characteristic impedance of 50 Ω, 4-terminal pair design, measurable conductor diameter: 0.3 to 1.5 mm (0.01 to 0.06 in)

**For Electrochemical Measurement**



**FOUR-TERMINAL PROBE 9500-10**

Cable length 1 m (3.28 ft), DC to 200 kHz, characteristic impedance of 50 Ω, 4-terminal pair design, measurable conductor diameter: 0.3 to 2 mm (0.01 to 0.08 in)

**DC Bias Unit**



**DC BIAS VOLTAGE UNIT 9268-10**

Direct connection type, 40 Hz to 8 MHz, maximum applied voltage: ±40 V DC



**DC BIAS CURRENT UNIT 9269-10**

Direct connection type, 40 Hz to 2 MHz, maximum applied current 2 A DC (maximum applied voltage: ±40 V DC)

\* An internal 300μH inductance is connected in parallel to the DUT.

\*When using the 9268-10 or 9269-10, external constant-voltage and constant-current sources are required.

**INTERFACE CABLE**



**GP-IB CONNECTION CABLE 9151-02**

2 m (6.56 ft) length

● **RS-232C Cable**

As RS-232C cable, use an interlink (crossover) cable.

The 9637 RS-232C cable (9-pin to 9-pin, crossed cable) cannot be used for applications involving the hardware flowcontrol.



DISTRIBUTED BY

*Note: Company names and product names appearing in this catalog are trademarks or registered trademarks of various companies.*

**DISTRAME S.A.** - Parc du Grand Troyes - Quartier Europe Centrale - 40, rue de Vienne - 10300 SAINTE-SAVINE  
Tél. : +33 (0)3 25 71 25 83 - Fax : +33 (0)3 25 71 28 98 - E-mail : [infos@distrame.fr](mailto:infos@distrame.fr) - Site internet : [www.distrame.fr](http://www.distrame.fr)